

MAGNETAR 9000

USER MANUAL

**ONE
MACHINE.
ALL GOLD.**

TOUT L'OR AVEC
UNE SEULE
MACHINE.

DEEP GOLD

SMALL GOLD

EXTREME GROUND



Nokta
DETECTION TECHNOLOGIES

READ CAREFULLY BEFORE USING THE DEVICE!

LEGAL NOTICES

Comply with the laws and regulations applicable in your area when using the device. Do not use the device in archaeological sites, historical ruins, or military zones. Always report any historical and cultural findings to the relevant authorities.

WARNINGS

MAGNETAR 9000 is an advanced electronic device manufactured with cutting-edge technology. Do not assemble or use your device without reading the user manual.

Do not expose the device and the Search Coil to extremely cold or hot environments for extended periods. (Storage Temperature: -4°F (-20°C) to +140°F (+60°C))

The device is designed to be waterproof up to 3 meters (10 ft) in accordance with IP68 standards. The Bluetooth® headphones are not included in this coverage.

After using the device especially in salt water, pay attention to the following:

1. Rinse the system box, shaft, and search coil with tap water; ensure no salt water remains on the connectors.
2. Never use chemical cleaners during cleaning of the device at any time.
3. After rinsing, wipe the shaft and display with a soft, non-scratching cloth to dry.

Protect the device from impact during use. During transportation, place the device in its original box and secure it with shock-resistant packaging materials.

The MAGNETAR 9000 may only be opened and repaired by authorized Nokta service centers. Opening the device for any reason will void the warranty.

IMPORTANT!

Do not use your device indoors. In environments with large amounts of metal, such as homes or buildings, the device may continuously produce target signals. For best performance, use your device outdoors and in open areas.

Do not operate your device within 10 meters of another detector or any device that emits magnetic waves, as this may cause interference.

Do not carry metal objects while using your device. While walking, keep the device as far away from your shoes as possible, as it may detect metal objects on your body or in your footwear as targets.

IMPORTANT! Your device may detect items that emit electromagnetic waves, such as a cell phone carried in your pocket, as targets and produce false signals.

TABLE OF CONTENTS

ASSEMBLY _____	: 3-8
How to Use the Detectobag	
Backpack _____	: 6-8
PACKAGE CONTENTS _____	: 9-10
GENERAL OVERVIEW OF	
THE DEVICE _____	: 11-12
DISPLAY OVERVIEW _____	: 13
EXPERT MENU _____	: 13
EASY MENU _____	: 14
BATTERY INFORMATION _____	: 15-16
CORRECT USE _____	: 17
QUICK START _____	: 18-19
EXPERT MENU AND	
SETTINGS MENU _____	: 19-20
MODE _____	: 20-21
USER PROFILE _____	: 21-22
GROUND _____	: 23
NOISE CANCEL _____	: 24-25
GROUND BALANCE _____	: 25-27
SENSITIVITY _____	: 27
VOLUME SETTINGS _____	: 28
THRESHOLD VOLUME _____	: 28
THRESHOLD FREQUENCY _____	: 29
AUDIO FILTER _____	: 29-30
STABILIZER _____	: 30
TARGET VOLUME _____	: 31
SETTINGS MENU _____	: 31-39
1. Backlight _____	: 32-33
2. Bluetooth® _____	: 33-35
3. Menu Colors _____	: 35
4. Language _____	: 35
5. Key Sounds _____	: 36
6. Key Vibration _____	: 36
7. Key Backlight _____	: 37
8. Flashlight _____	: 37
9. Device Info _____	: 38
10. Factory Reset _____	: 38-39

TABLE OF CONTENTS

UPDATE (PROGRAMMING) MODE _____	: 39
SOFTWARE UPDATE _____	: 39
ERROR CODES _____	: 39
WARNING MESSAGES _____	: 39
RECOVERY _____	: 40
HEADPHONE INFORMATION _____	: 40
TECHNICAL SPECIFICATIONS _____	: 41-42



ASSEMBLY

(1) After placing the gaskets into their slots on the lower shaft, fit the lower shaft onto the search coil. Secure the search coil to the lower shaft using the coil mounting hardware. Be careful not to overtighten.

(2) To connect the mid shaft with the lower and upper shafts, open the shaft latch replacement and slide the shafts into each other. Then, adjust the length of the device to your height, tighten using the side screws, and close the shaft latch replacement.

(3) Wind the search coil cable around the shaft without excessive tension as shown in the figure (Figure A).



Figure A

Then insert the connector into the search coil input on the device as shown in the figure (Figure B) and secure it by tightening the nut. You may hear a “click” sound during tightening. This indicates that the connector is fully locked.

Figure B:



Önemli Not: Align the search coil cable connector with the search coil input on the device and insert it. The connector is keyed to fit in only one direction. To avoid damaging the connection pins, do not force the connector; ensure that the internal guide notch is perfectly aligned with the slot. Once properly aligned, secure it by tightening the nut.



(4) Secure the cable using the cable routing compartment located at the bottom of the upper shaft, as shown in the figure (Figure C).

Figure C:



(5) Hold the MAGNETAR 9000 battery with the text on the front facing in a readable direction, and place it into the slot as shown in the figure (Figure D). After pushing the battery all the way into the slot, complete the securing process using the latches on the right and left sides as shown in the figure (Figure E).

Figure D:



Figure E:



(6) If you want to adjust the armrest, open the latch. Once it reaches the desired height, close the latch as shown in (Figure F) to secure it.

Figure F:



(7) Attach the armrest strap as shown in the figure (Figure G) and adjust it by tightening according to the width of your arm.

Figure G:



(8) Attach the ferrite ring included with the device to the detector using the hook & loop tape fastener as shown in the figure (Figure H).

Figure H:



IMPORTANT! When using the headphone and update port, you may secure the dust cap as shown in the figure (Figure I), in the holder located directly below it.

Figure I:



How to Use the Detectobag Backpack

1. Put the backpack on your back. Adjust the tightness of the waist belt using the straps on the right and left sides as shown in the figure, then fasten the belt buckle. You will hear a click sound. Pull the tabs on the right and left straps forward to ensure the belt sits snugly on your waist.



IMPORTANT! Properly fitting the belt to your body is essential for using the bungee support stick. You can proceed to the next steps after fastening the belt.

2. Fasten the chest strap buckle as shown. You will hear a click sound.



Adjust the tightness of the strap by pulling the slider to the left as shown in the figure.



3. Adjust the chest strap height to your chest level by moving the attachment on either side of the backpack up or down as shown in the figure. This allows you to adjust the distance for comfortable use.



4. Use the tabs hanging from the chest strap to adjust the backpack's alignment on your back.

IMPORTANT! If you have a suitable vest that can replace the backpack, you can follow the same steps with the vest.

Hipstick & Bungee Assembly

IMPORTANT! The bungee support stick provides the connection between your waist and chest, and enables you to attach the bungee cord.

1. Attach the ball-shaped plastic socket onto the right side of the waist belt with the socket facing upward as shown in the figure.



2. To adjust the bungee support stick length, pull out the plastic piece on the stick. Adjust the height by extending or shortening the telescoping tubes as shown, and align the holes on both tubes. Once the holes are aligned, insert the removed piece through the holes using the pin on the plastic piece as shown. You will hear a click when the pin locks into place.



3. Attach the ball at the bottom of the bungee support stick to the plastic socket you installed on the right side of the waist belt as shown. You will hear a click indicating it is fully locked.



4. Thread the hook at the top of the bungee support stick through one of the 3 holes at shoulder level on the backpack, choosing the appropriate height for your body as shown.



Bungee Cord Assembly

1. Attach the hook & loop tape to the lower shaft of the device with the hook opening facing outward as shown in the figure.



2. Thread the hole on the bungee cord through the hook on the hook & loop tape attached to the lower shaft as shown in the figure.



IMPORTANT! Attaching the bungee cord to the lower shaft of the device is the recommended method of use.

3. Thread the hook at the other end of the bungee cord through the hole on the bungee support stick at shoulder level of the carrying backpack, with the NOKTA logo on the hook facing toward you as shown.



IMPORTANT! At this point, also adjust the armrest strap to the width of your arm. With the bungee cord, you can easily maneuver the device while searching.

5. When you want to dig a target at the search location, you need to detach the bungee cord from the backpack. Remove the bungee cord latch from the hole on the bungee support stick at chest level, and attach it to the armrest of the device, then you can set the device on the ground.

IMPORTANT! This usage can be applied to the backpack for either left-hand or right-hand use. The steps described in this manual are shown for a right-handed user. For left-hand use, apply the same steps to the left side of the backpack.

IMPORTANT! These steps make it easier to carry the device and maneuver it during searching.

IMPORTANT! Having the NOKTA logo on the hook facing toward you is important for the bungee cord to lock properly.



4. The bungee cord locks by pressing and pulling downward until the device stays balanced at the desired height. To unlock the bungee cord, pull it upward.



PACKAGE CONTENTS

Waterproof DRC Search Coil & Cover
MG37-DRC 14.5" x 13" / 37 cm x 34 cm



MG29-DRC 11" x 8" / 29 cm x 21 cm



Nokta Bluetooth® Headphones & Charging Cable



1/4" / 6.3 mm Headphone Adapter Cable



2 x Lithium-Ion Batteries



AC Charger & Universal Adapters



Car Charger



Car Battery Charging Cable



PACKAGE CONTENTS

Detectobag Backpack



USB Data Cable



Ferrite Ring



Hipstick & Bungee



Nokta Standard Digger



GENERAL OVERVIEW OF THE DEVICE

**1. LCD Display****2. Power On/Off Button**

Press and hold for approximately 1 second to turn on the device. To turn off, press and hold the button for approximately 3 seconds.

3. Select Button

Used to enter the settings menu from the Expert Menu and to confirm changes made in certain features. It has different functions in specific features, which are detailed in the relevant sections.

4. Right and Left Navigation Buttons

Used to navigate through the Expert Menu or settings menu.

5. Up and Down Navigation Buttons

Used to scroll forward or backward through the sub-options of the selected feature in the Expert Menu or settings menu. Additionally, in some cases, they are used to increase or decrease the value of a selected feature: each press of the up or down navigation button adjusts the value by one step.

6. Profile Button

Allows you to save your frequently used search settings on the device and quickly access stored settings. Additionally, while in the Easy Menu, you can press the profile button to quickly switch to the Expert Menu.

7. Back Button

Used to return to the top-level menu. When in the settings menu, pressing the back button returns the device to the Expert Menu.

**8. Flashlight****9. Ground Balance Trigger**

This trigger allows you to perform auto Ground Balance on the MAGNETAR 9000. For details, see pages 25–27.

GENERAL OVERVIEW OF THE DEVICE

10. Wired Headphone and Computer Port

11. Speaker

12. Search Coil Input

Important Note: The computer port is used for device firmware updates.

IMPORTANT! Keep the dust cap attached when the connector is not in use!

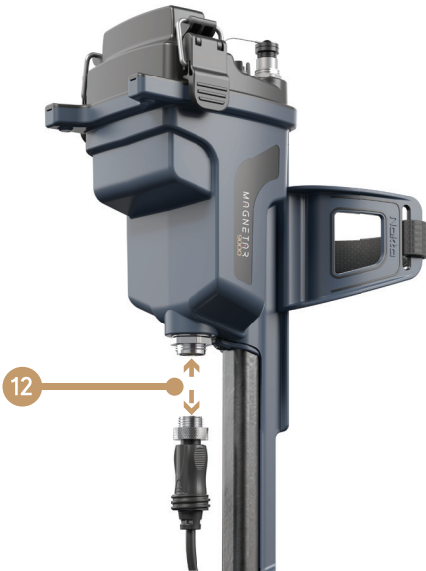

DISPLAY OVERVIEW

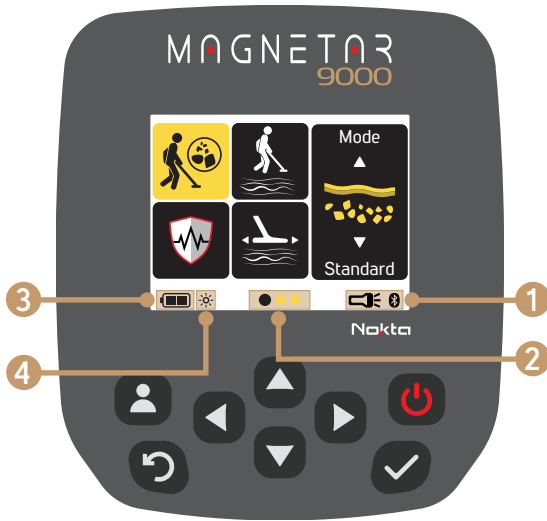

- 1. Flashlight & Bluetooth®
- 2. Screen Toggle
- 3. Battery Indicator
- 4. Backlight

EXPERT MENU

The MAGNETAR 9000 Expert Menu contains a total of 12 different features across 3 separate screens. For detailed information about the screens, refer to pages 18-39 of this manual.

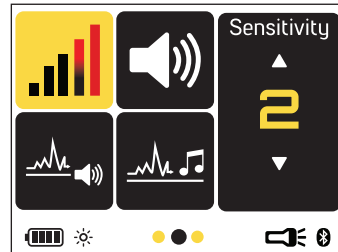
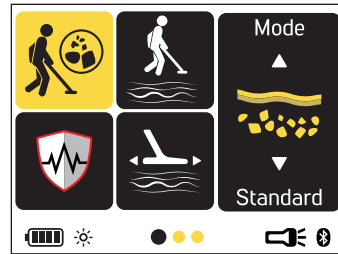

EASY MENU

When MAGNETAR 9000 is first turned on, it presents you with 2 different menu options: Easy and Expert.

To continue searching with the Easy Menu, select the Easy Menu using the right or left navigation buttons. Confirm your selection with the select button within 5 seconds. Wait until the device is ready. If you do not make a selection within 5 seconds, the device will continue with the last selected menu.



IMPORTANT! When the device enters the Easy Menu, Mode is set to Maximum, ground is set to Regular, and Ground Balance is set to auto. In the Noise Cancel feature, only auto Noise Cancel can be performed. The auto-off timer cannot be adjusted (the backlight remains always on); however, you can increase or decrease the brightness level by one step at a time.

IMPORTANT! For detailed information on all features in the Easy Menu, refer to pages 23–37 of this manual.

IMPORTANT! While in the Easy Menu, the speaker is disabled in the Bluetooth® option. To turn the speaker on and off, enter the Expert Menu.

You can also quickly enter the Easy Menu from the Expert Menu using the profile button.

How to Enter Easy Menu from the Expert Menu Using the Profile Button?

Press the profile button and on the screen that appears, navigate to the Easy Menu option using the right or left navigation buttons.



Press the profile button again to enter the Easy Menu.



IMPORTANT! To exit the Easy Menu, press the profile button again.

BATTERY INFORMATION

The MAGNETAR 9000 battery is external and is a 6600mAh Lithium-Ion battery.

Battery life varies between 7-10 hours. The device's settings, speaker or wired/wireless headphone usage, backlight, flashlight, and other factors affect battery life.

Charging

Always charge the MAGNETAR 9000 battery before first use.

The charging time for a fully depleted battery is approximately 5 hours.

To charge the battery, place it on the charging unit provided with the device.



Connect the adapter of the charging cable to a power outlet and the other end to the charging input on the charging unit.



IMPORTANT! The USB-C connector of the charging unit provides a 5V 0.67A power output; this output can be used to charge external devices.



Charging the Battery

Three different methods are available for charging the MAGNETAR 9000 battery. Before starting the charging process, remove the battery from the device and place it on the charging unit; make sure the connector pins are fully aligned.

You can use one of the following methods by plugging your preferred charging accessory into the socket on the back of the charging unit:

1. Wall Charger:

Plug the charger adapter into a standard wall outlet to begin charging.

2. Car Charger:

Connect the car charger cable to your car's cigarette lighter socket to charge.

3. Car Battery Charging Cable:

If drawing power directly from a battery, first connect the black negative (-) clamp to the negative terminal, then connect the red positive (+) clamp to the positive terminal.

Charging Indicator:

Leave the battery to charge fully. The flashing green light during charging will turn to a steady green light when the battery is full; this process may take up to four hours.

WATERPROOF REPLACEABLE SPARE BATTERY

You can easily mount the battery into the slot on the top of the system box as shown in the figure.



You can easily charge the battery by removing it from its slot and using the included charger.

WARNING! Do not leave the device in rain or underwater when the battery is removed from its slot!

Low Battery Level

The battery icon on the device display shows the battery charge level. The number of bars inside the battery icon also decreases as the battery level drops. When the battery is depleted, a low battery icon appears on the screen and the device shuts down.

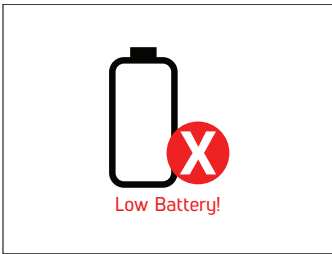

IMPORTANT! After the low battery alert, pressing the back button allows for extended operation until the device automatically powers off.

BATTERY WARNINGS

Do not leave the device in extremely hot or cold conditions (e.g., in the car's glove compartment or trunk).

Do not charge the battery at temperatures above 95°F (35°C) or below 32°F (0°C).

BATTERY CHARGING INSTRUCTIONS

Battery Specifications

Type: Rechargeable Lithium-Ion battery

Output Voltage Lithium-Ion: 7.2V DC

Lithium-Ion battery capacity: 48Wh

Operating Time: 7-10 hours

Lithium-ion battery weight: 9.6 oz (270 g)

IMPORTANT! When removing and reinserting the battery for charging, pay close attention to the gasket shown in the figure to ensure watertight sealing.



Any foreign materials such as dirt, sand, or mud on the gasket surface must be thoroughly cleaned before reinserting the battery into the device. Otherwise, water ingress may occur.

During the Charging Process

When the charging unit is connected to the outlet via the adapter, the Power LED will illuminate in solid green. Upon inserting the battery into the charging unit, the Green LED indicators will flash in sequence. This sequence indicates that the battery is currently charging.

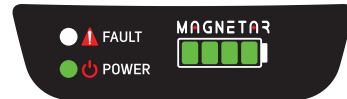

Important Note: If an error occurs while the battery is in the charging unit, the Error LED will turn on in solid red.

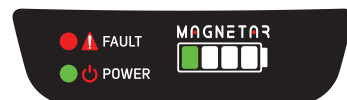

CORRECT USE

Device height incorrectly adjusted

Properly adjusting the height of your device to your body is very important for searching without fatigue or strain.

Metals that may be on you or your shoes during searching can cause the device to detect them and produce misleading signals.



Device height correctly adjusted

Adjust the device to your height with your body upright, arm relaxed, and the Search Coil approximately 5 cm (2") above the ground.

When the device height is properly adjusted, the risk of false signals caused by metals on your body and shoes is significantly reduced.



Correct Sweeping

Search coil angle incorrect



Search coil angle correct



Sweep pattern incorrect

Maintaining the Search Coil parallel to the ground is important for obtaining accurate results.



Sweep pattern correct

The search coil should always be kept parallel to the search surface.



QUICK START

1) Assemble the device by referring to the assembly section on pages 3–8.

2) Turn on the device by pressing and holding the power on/off button for 1 second. After the Nokta and MAGNETAR 9000 startup screens, the easy and Expert Menu selection screen will appear.



Select the menu you want to use by pressing the right or left navigation buttons. Confirm your selection with the select button within 5 seconds. Wait until the device is ready.



IMPORTANT! The easy and Expert Menus are offered to customize the user experience and determine the device's operational flexibility. Beginner users can choose the Easy Menu for high performance without wasting time. Professional users can choose the Expert Menu for full access to advanced settings.

IMPORTANT! If you do not make a selection, MAGNETAR 9000 will continue with the menu selected during the last use.

3) When the device is first turned on in the Expert Menu, the Mode option is selected. You can change the Mode using the up or down navigation buttons according to the terrain where you want to search. The selected Mode appears on the right side of the screen. Details about the Modes can be found in the following sections of this manual.



IMPORTANT! The section on the right side of the screen shows the sub-options of the selected feature. Any setting changes you make can be monitored from the right side.

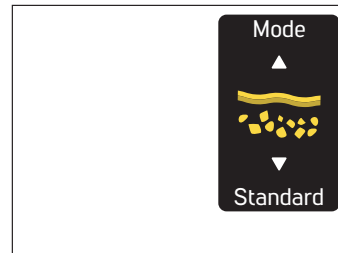

The Importance of Ground Balance on MAGNETAR 9000

IMPORTANT! If you use the device without performing a Ground Balance, you may receive false signals from the ground.

Ground Mineralization and Noise Management

Most soil structures on earth are not just sand; they also contain various chemical substances, minerals, and salts. The presence of these additional components is called "Ground Mineralization."

If Ground Balance is not performed, this mineralization produces irregular signals causing "Ground Noise," a type of interference. This noise makes it significantly harder to detect weak signals from small or deeply buried targets.

Ground Balance on MAGNETAR 9000

The Ground Balance feature on MAGNETAR 9000 precisely measures the mineral density (ground mineralization) in the soil and automatically adapts itself accordingly. This adaptation process minimizes ground noise.

As a result, this optimization prevents the signals from valuable targets such as gold from being mixed with interference signals caused by the ground, allowing them to be clearly distinguished.

4. If you wish, you can increase the Sensitivity setting on the second screen using the up navigation button. Increasing the Sensitivity will provide greater depth. However, if the environment or ground causes the device to pick up noise, you will need to decrease the Sensitivity using the down navigation button. After adjusting the Sensitivity, you can begin searching.













5) You are now ready to start searching.

EXPERT MENU AND SETTINGS MENU

Changes made in these settings apply to all Modes. Even if the selected Mode is changed, the settings remain the same.

The Expert Menu and settings menu are indicated in this manual as follows:

Expert Menu

-  Mode
-  Ground
-  Noise Cancel
-  Ground Balance
-  Sensitivity
-  Volume
-  Threshold Volume
-  Threshold Frequency
-  Audio Filter
-  Stabilizer
-  Target Volume

 Settings Menu

 Backlight

 Bluetooth®

 Menu Colors

 Language

 Key Sounds

 Key Vibration

 Key Backlight

 Flashlight

 Device Info

 Factory Reset

MODE

MAGNETAR 9000 has 3 Modes adapted to different ground conditions and target types.

IMPORTANT! The factory default setting is Maximum Mode.



Switching Between Modes

Choosing the appropriate Mode in gold searching and metal detection directly affects your search success. MAGNETAR 9000 features 3 Modes specifically adapted to various target sizes and depths. An incorrect Mode selection may cause targets to be missed. Correct Mode selection plays a critical role in achieving more accurate results.

How to Change Mode?

Navigate to the Mode option in the Expert Menu using the right or left navigation buttons. Select the Mode you want to use with the up or down navigation buttons. The selected Mode appears on the right side of the screen.



Modes



MAX

Max Gold Mode is specifically designed for hard-to-detect targets such as small gold pieces and near-surface gold dust. Although designed for high sensitivity to small targets, it is also extremely sensitive to medium-sized and moderately deep targets. This is the recommended Gold Mode.



STANDARD

Standard Gold Mode is designed for general-purpose use. It provides similar sensitivity to gold of all sizes. It may miss very small and/or deep targets.



DEEP

Deep Gold Mode is designed for deep and relatively larger targets. This Mode may miss or have difficulty detecting small gold pieces and/or near-surface fine gold.

How to Save to User Profile?

Press the profile button on your device and navigate to the Save option on the screen that appears using the right or left navigation buttons. Press and hold the select button for 3 seconds.



This will save the device's current settings. You can load these settings from memory each time you turn on the device and continue using the same settings.

IMPORTANT! When the profile save is complete, the Load option becomes active to load the saved settings.



USER PROFILE













The profile menu allows the user to save frequently used search settings on the device and quickly access stored settings. MAGNETAR 9000 instantly applies and stores the user's settings in memory. When you turn the device off and on again, it opens with the last used settings. To prevent the loss of frequently used settings while making changes, you can save these settings to the device's memory via the profile menu. This way, you can quickly access your favorite settings across different gold searching environments.

IMPORTANT! MAGNETAR 9000 saves your settings to your user profile.

IMPORTANT! You can only access the Profile Menu by pressing the profile button while in the Expert Menu.

Saveable Settings

-  Mode
-  Ground
-  Noise Cancel
-  Ground Balance
-  Sensitivity
-  Volume
-  Threshold Volume
-  Threshold Frequency
-  Audio Filter
-  Stabilizer
-  Target Volume

SAVED SETTINGS

Allows you to revert to your previously saved settings if changes have been made to the existing saved settings while using the device.

How to Load Saved Settings?

Press the profile button on your device and navigate to the Load option on the screen that appears using the right or left navigation buttons. Press and hold the select button for 3 seconds.



How to Delete Saved Settings?

To reset your previously saved user settings, press the profile button on your device and navigate to the reset option using the right or left navigation buttons on the screen that appears. Press and hold the select button for 3 seconds.



The device will delete all saved settings and revert to the factory default values.

IMPORTANT! As mentioned earlier, you can quickly access the Easy Menu from the profile menu entered via the profile button.



While in the Easy Menu, you can press the profile button to quickly switch to the Expert Menu.

GROUND



You can choose from ground options designed according to the difficulty level of the terrain. Iron oxide, salt minerals, and other conductive elements in the soil can cause false signals. Three different ground options — Regular, Tough, and Extreme — have been designed to eliminate ground-related false signals.

Correct ground selection plays a critical role in achieving more accurate results. If you are unfamiliar with the terrain where you will be searching, start with the Regular ground setting and perform a Ground Balance. If you are unable to eliminate ground-related false signals, consider trying other ground options.

IMPORTANT! The factory default ground setting is Tough.

How to Change Ground?

Navigate to the ground option in the Expert Menu using the right or left navigation buttons. Select the ground setting you want to use with the up or down navigation buttons. The selected Ground appears on the right side of the screen.



IMPORTANT! If you select Extreme ground, the Mode option will become inactive. When Extreme ground is selected, the device disables other Modes for maximum efficiency and operates with Maximum Gold Mode. This is a setting that ensures error-free searching due to extreme mineral density in the soil; simply change the ground selection to use other Modes.



Ground



REGULAR

The recommended setting for non-mineralized (low-mineral) ground. When mineral density in the ground is low, the MAGNETAR 9000 can achieve greater depth, and false signals are reduced. If unwanted ground noise (false signals, interference, etc.) is heard, the ground is mineralized. In such cases, switching to the Regular (medium-mineral) setting will reduce noise and provide a more stable search.



TOUGH

The recommended setting for mineralized (medium-mineral) ground. Gold is generally found in soils with moderate to high mineralization. These conditions may cause noise and false signals on the MAGNETAR 9000. This ground option reduces interference for more stable and accurate searches. No significant depth loss occurs with this setting, although performance may be minimally affected. If unwanted ground noise (false signals, interference, or meaningless sounds) continues during searching, the ground may be highly mineralized. In this case, select the Extreme ground option.



EXTREME

Designed for working in very highly mineralized grounds. This setting provides the highest ground filtering but may cause depth loss compared to other ground settings.

This setting can only be selected with Maximum Gold Mode. To switch to other Gold Modes, you must first select Regular or Tough ground options.

NOISE CANCEL



Electromagnetic interference from the external environment (other detectors operating nearby, high-voltage power lines, cell phone towers, two-way radios, other electromagnetic devices, etc.) are factors that reduce the device's sensitivity. The Noise Cancel feature is used to move away from such signal interference and perform a calmer, more sensitive search. MAGNETAR 9000 offers 256 frequency channels, allowing operation even in the most intense noisy environments.

IMPORTANT! The factory default setting is 128.

Noise Cancel is the first operation that should be performed before using MAGNETAR 9000.

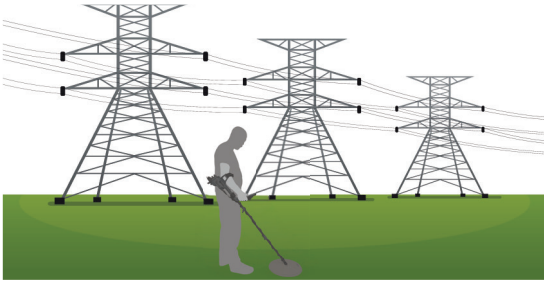

If the device picks up excessive noise while holding the Search Coil in the air, the cause is electromagnetic signals from the surroundings. In this case, using the Noise Cancel feature is recommended.

For maximum depth, it is strongly recommended to first use the Noise Cancel feature to eliminate noise caused by electromagnetic signals from the environment. It is also strongly recommended to perform Noise Cancel every time you turn on the device.

IMPORTANT! Noise Cancel on MAGNETAR 9000 is performed in two ways: manual and auto.

In manual use, the user listens to each channel and selects the one with the least noise.

In auto use, the device scans all channels and selects the one with the least noise. This feature is called Noise Cancel.

How to Adjust Manual Noise Cancel?

Navigate to the Noise Cancel option in the Expert Menu using the left or right navigation buttons. Use the up or down navigation buttons to cycle through the available channels while listening carefully to the device's audio response on each one. Select the channel with the least interference. The selected channel value is displayed on the right side of the screen.



How to Adjust Auto Noise Cancel?

1. Navigate to the Noise Cancel option in the Expert Menu using the right or left navigation buttons and press the select button.



2. When you press the select button, auto scanning will start on the screen.

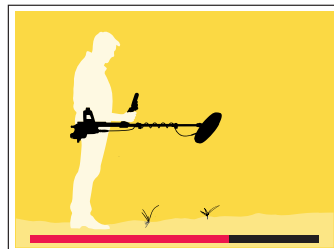

3. Raise the device in the air as shown and hold it steady until the process is complete (approximately 50 seconds). Make sure there are no large metal objects nearby.

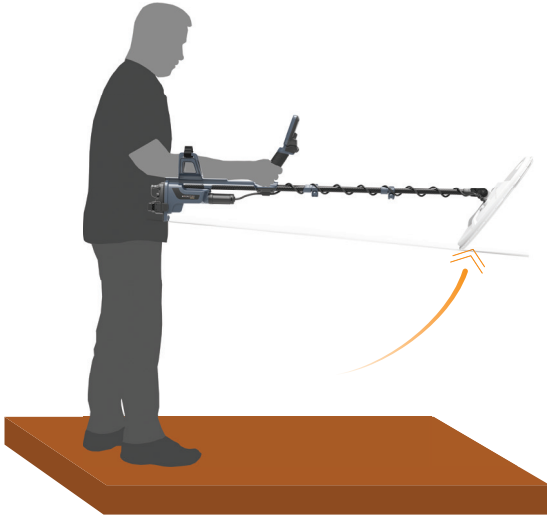

Your device scans all channels starting from the first. When the process is complete, a confirmation mark appears on the screen and a confirmation tone is heard indicating the process is finished.



The automatically determined channel value will then appear on the right side of the screen.

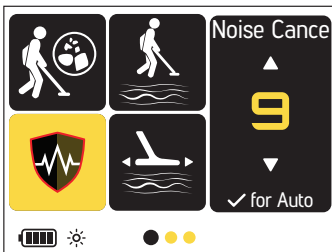

IMPORTANT! The Noise Cancel process minimizes interference signals such as environmental noise, allowing your device to receive cleaner signals.

GROUND BALANCE



Ground Balance is a critical process for the device to adapt to the minerals in the ground. Iron oxide, salt minerals, and other conductive elements in the soil can cause the device to produce false signals. A device without Ground Balance may perceive non-metallic minerals as metal. False signals lead to unnecessary digging and wasted time. The use of the trigger for Ground Balance is one of the most important features of this device. Performing Ground Balance using the trigger with the ferrite ring is critically important for accurate calibration.

Proper Ground Balance improves the ability to detect even small gold targets at depth. It helps prevent missed targets, particularly in difficult or mineralized terrain, and provides a more stable search experience. By reducing ground noise, it allows you to focus on true targets. Proper Ground Balance is essential for effective gold prospecting.

IMPORTANT! A properly performed Ground Balance provides deeper, more accurate, and more stable searching, and saves you from false signals.

MAGNETAR 9000 offers 3 different Ground Balance settings to ensure the best performance in various ground conditions. Each setting is customized for the terrain type and usage needs.

IMPORTANT! The factory default Ground Balance setting is auto.

How to Perform Ground Balance?

Navigate to the Ground Balance option in the Expert Menu using the right or left navigation buttons. Select the Ground Balance option you want to use with the up or down navigation buttons and press the select button to confirm your selection. The selected Ground Balance setting appears on the right side of the screen.



IMPORTANT! To activate your selection, you must confirm the new mode by pressing the select button.

IMPORTANT! When you change the Ground Balance mode and confirm a different mode, the animation you see on screen indicates that you need to perform a Ground Balance again with the ferrite ring. Otherwise, you will continue to receive interference signals.



Ground Balance Options

IMPORTANT! When manual or semi auto is selected, it is strongly recommended to perform Ground Balance using the trigger with the ferrite ring on the ground before starting your search!



AUTO

In the auto setting, your device tracks the changing conductive and magnetic conditions of the soil to minimize false signals from the ground. It provides a more stable search compared to the semi auto mode in grounds with intense magnetic content.



SEMI AUTO

In the semi auto setting, your device tracks the changing conductivity of the soil to minimize false signals from the ground. If you are using the device on different ground types, the semi auto setting may be beneficial.



MANUAL

In this setting, ground tracking is disabled and changes in ground conditions are not updated in the MAGNETAR 9000's ground model. It may be used after performing an initial Ground Balance in areas with a stable, non-changing mineral composition.

Auto Ground Balance

Performing a correct Ground Balance before starting gold detecting is a critical step to prevent false signals and ground-related effects. A properly performed Ground Balance increases your device's sensitivity, providing more reliable results.

How to Perform Ground Balance?

To avoid false signals, select a clean ground surface free of metal. Place the MAGNETAR 9000's yellow ferrite ring on the ground. Pull the trigger and follow the on-screen instructions. Hold the Search Coil approximately 1.5-2in (4-5 cm) above the ground and swing it side to side. Maintain a consistent height above the ground throughout the movement, passing over the ferrite ring as well. Continue swinging until no audio response is heard from either the ferrite ring or the ground. Side-to-side swinging is the primary method for Ground Balance; the up-and-down (pumping) motion is not recommended. Pumping may be used after Ground Balance is completed to check for residual ground effects. Ground Balance can be repeated at any time using the trigger, not only at startup but also during searching if the device begins producing false signals, especially in manual and semi auto modes.

The Role of the Ferrite Ring Ground Balance

For optimal Ground Balance, a standard reference material is required. The ferrite ring, with its stable magnetic permeability, serves as an ideal reference object. The device is calibrated using the ferrite ring in conjunction with the Search Coil. The ferrite ring represents a concentrated reference of the magnetic properties commonly found in soil. In areas with weak magnetic properties, calibration using the ferrite ring is essential to achieve accurate Ground Balance.

The ferrite ring provides a consistent and known response due to its constant magnetic permeability, making it an ideal reference model for Ground Balance.

What Happens Without the Ferrite Ring?

Ground Balance performed without the ferrite ring reduces the overall quality of the calibration and may cause the following problems:

1. The device may receive false signals, and the sensitivity to detect small metals may decrease.
2. The detection depth of the device may decrease. Overall performance and accuracy may be negatively affected. Therefore, performing Ground Balance with the ferrite ring is critically important for maximum efficiency and accurate detection.

SENSITIVITY



This is the depth setting of the device. It is also used to manage noisy signals received from electromagnetic sources in the environment and from the ground.

When the sensitivity level is increased, MAGNETAR 9000 can detect smaller and deeper targets. However, excessively high sensitivity may cause false signals due to electromagnetic signals from the environment (power lines, radios, cell phone towers, etc.) and noisy signals from the ground (minerals, salt, iron oxide, etc.).

Therefore, the ideal sensitivity level should be set at a point where the device can operate stably at maximum depth, noise is at a minimum, and false signals are minimized.

Hearing some background noise during searching is normal and is beneficial to ensure deep targets are not missed. An extremely quiet environment may indicate that deep targets are not being detected due to excessively low sensitivity.

IMPORTANT! Sensitivity has 20 steps, and the default setting is 15.

The sensitivity level is a personal preference. However, it is important that sensitivity is set at the highest value where significant audio bursts are not heard but a slight amount of noise is present, to avoid missing small and deep targets.

For example, if the noise levels at sensitivity 15 and 20 are similar and suitable for searching, the level of 20 should be preferred.

The sensitivity setting is common to all modes, and any change affects all modes.

How to Adjust Sensitivity?

Navigate to the Sensitivity option in the Expert Menu using the right or left navigation buttons. Increase or decrease the sensitivity value by one step at a time using the up or down navigation buttons. The selected sensitivity value appears on the right side of the screen.



When you turn on the device, it starts at the last adjusted sensitivity level.

IMPORTANT! For maximum depth, rather than reducing sensitivity too much, it is recommended to first try the Noise Cancel feature to eliminate noise caused by electromagnetic signals from the surroundings.

VOLUME SETTINGS



The volume level setting allows you to control the detector's overall audio level according to your surrounding conditions or personal preference.

IMPORTANT! Volume has 20 steps, and the default setting is 15.



At Volume Level 1, weak target signals are heard quietly, medium target signals at a normal level, and strong target signals are heard loudly. At this setting, the difference in volume between signal strengths is most pronounced. However, weak signals may be more difficult to hear.



At Volume Level 20, all target signals are amplified to a high-volume audio response. At this setting, there is less differentiation between medium and strong signals; however, weak signals are easier to hear. This setting can be adjusted based on the search environment and target depth for optimal performance.

IMPORTANT! Lower volume levels may be preferred in quiet environments, while higher volume levels are recommended when it is important not to miss weak signals.

How to Adjust Volume?

Navigate to the Volume option in the Expert Menu using the right or left navigation buttons. Increase or decrease the volume value by one step at a time using the up or down navigation buttons. The selected volume value appears on the right side of the screen.



THRESHOLD VOLUME



The continuous "hum" sound produced by the MAGNETAR 9000 in the background is called the threshold. The threshold is used to increase the device's sensitivity and make weak signals easier to hear. It plays an important role in detecting very small or deeply buried gold targets.

Small changes in the threshold indicate the presence of a target. An appropriate threshold volume makes it easier to distinguish the signal from the background hum.

Setting the threshold to a barely audible level provides the best results. This way, target signals clearly separate from the threshold.

If the threshold volume level is set too high, faint or weak target signals become difficult to hear over the loud threshold hum. A continuously high hum can cause discomfort and make it harder to distinguish false signals.

IMPORTANT! Set the threshold to a level where you can hear it clearly but not at a level that causes discomfort. Make sure that weak signals can be easily noticed above the hum.

IMPORTANT! Threshold Volume has 50 steps, and the default setting is 25.

How to Adjust Threshold Volume?

Navigate to the Threshold Volume option in the Expert Menu using the right or left navigation buttons. Increase or decrease the threshold volume value by one step at a time using the up or down navigation buttons. The selected threshold volume value appears on the right side of the screen.



THRESHOLD FREQUENCY



Used to adjust the frequency (pitch) of the continuously heard threshold tone in the background.

Threshold frequency determines how high-pitched (high frequency) or low-pitched (low frequency) the threshold sound will be.

IMPORTANT! Since hearing sensitivity varies from person to person, adjusting the threshold frequency to the most comfortable level for your hearing will help you distinguish target signals more easily.

IMPORTANT! The Threshold Frequency has 100 steps, and the default setting is 53.

How to Adjust Threshold Frequency?

Navigate to the Threshold Frequency option in the Expert Menu using the right or left navigation buttons. Increase or decrease the threshold frequency value by one step at a time using the up or down navigation buttons. The selected threshold frequency value appears on the right side of the screen.



AUDIO FILTER



While using MAGNETAR 9000, sometimes highly fluctuating ground signals can make the search process difficult. It can become challenging to detect metal targets amid constantly changing background sounds. As the Audio Filter increases from Off to High, the background sound becomes smoother and calmer. However, this may cause loss of weak targets.

The Audio Filter reduces ground-related fluctuations, providing a more stable audio output. This ensures that the user hears a clear change only when metal is detected, resulting in a more comfortable search experience.

IMPORTANT! MAGNETAR 9000 comes factory-set with the Audio Filter turned Off.

MAGNETAR 9000 is designed to work with maximum sensitivity on all ground types. However, in some cases, the Audio Filter feature can be used to smooth out ground effects.

When Should the Audio Filter Be Used?

1. When ground-related signals cause excessive fluctuation.
2. When reducing the sensitivity level or adjusting the threshold volume does not sufficiently resolve these effects.
3. When a more stable search audio is desired, you can use the audio filter.

IMPORTANT! When the Audio Filter is enabled, sensitivity to small metal targets may be reduced.

How to Adjust the Audio Filter?

Navigate to the Audio Filter option in the Expert Menu using the right or left navigation buttons. Select the audio filter option you want to use with the up or down navigation buttons. The selected audio filter setting appears on the right side of the screen.



The Audio Filter offers 3 different level options based on user needs:



1. Off

The audio filter is disabled. Processes all ground signals and provides maximum sensitivity.



2. Low

Filters slight fluctuations. Reduces medium-level ground effects and balances the search experience.



3. High

Applies stronger filtering. Minimizes ground effects to focus only on prominent metal targets.

STABILIZER



The Stabilizer makes your device more stable on salty grounds such as beaches, enabling a more reliable search experience.

IMPORTANT! MAGNETAR 9000 comes factory-set with the Stabilizer turned Off.

On salty grounds, detectors often produce continuous long signals as if metal were present. This can cause real metal targets to become lost within these signals, making it difficult for the user to notice actual metal.

The Stabilizer regulates these types of signals to help you achieve clearer and more discernible detection.

IMPORTANT! The Stabilizer may reduce depth. Therefore, it should only be used on salty grounds where you truly cannot operate.

When Should You Use the Stabilizer?

When your device produces erratic signals on salty grounds (beaches, mineralized grounds, etc.), continuous long signals as if metal were present, and real metals within these signals become hard to detect, you should use the Stabilizer.

How to Adjust the Stabilizer?

Navigate to the Stabilizer option in the Expert Menu using the right or left navigation buttons. Select the Stabilizer option you want to use with the up or down navigation buttons. The selected Stabilizer setting appears on the right side of the screen.



The Stabilizer offers 3 different level options based on user needs:



1. Off

If your device is operating normally or no salty ground effects are observed, the Stabilizer should be kept off. This preserves maximum depth.



2. Low

If your device produces erratic signals on mildly salty or mineralized grounds, the low level is recommended. It provides stability with very minimal depth loss. This setting also allows you to cover a larger area in a shorter time.



3. Medium

If your device produces heavily distorted signals on very salty and extremely mineralized grounds, the medium level should be used. At this setting, the device's target response speed increases and the background sound becomes more active. Depth loss may be greater compared to other levels.

TARGET VOLUME



Sets the maximum volume level for target signals. Target Volume prevents sudden, loud sounds from harming your ears, especially when large and shallow targets are detected.

High Volume Limit: Creates a more noticeable volume difference between large and small targets. Deep or weak signals become easier to notice. Provides better insight into the target's size and depth. However, large near-surface targets may produce sudden loud sounds that can be uncomfortable.

Low Volume Limit: Reduces the volume difference between large and small targets. Sudden loud sounds are prevented, providing comfort during extended use. Your ears are protected when using headphones. However, since the volume difference is reduced, distinguishing large and small targets by audio level may become more difficult.

IMPORTANT! If you are using headphones, set it to low-medium levels.

IMPORTANT! When searching for weak targets, a higher volume limit provides better results.

In noisy environments, medium levels provide a balanced experience. For extended searches, use lower levels to prevent ear fatigue.

IMPORTANT! The Target Volume setting has 20 levels, and the default setting is 15.

How to Adjust Target Volume?

Navigate to the Target Volume option in the Expert Menu using the right or left navigation buttons. Increase or decrease the target volume value by one step at a time using the up or down navigation buttons. The selected target volume value appears on the right side of the screen.









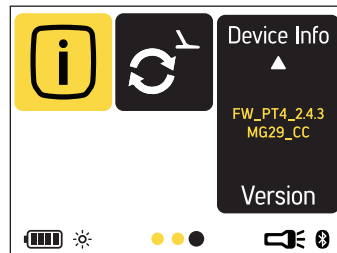
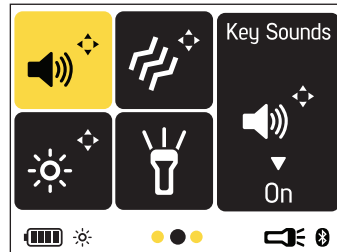
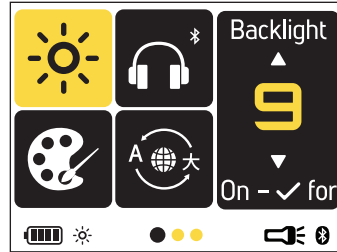



SETTINGS MENU



The MAGNETAR 9000 settings menu consists of 3 separate screens. For detailed information about the screens, refer to the following pages of this manual.



The settings menu allows you to personalize and optimize the MAGNETAR 9000 experience. Below you can find all the options and their functions available in the menu:

-  **1. Backlight**
Allows you to manage battery consumption by adjusting screen brightness.
-  **2. Bluetooth®**
You can turn the Bluetooth® connection on or off, or perform pairing.
-  **3. Menu Colors**
You can change the color theme of the screen menu.
-  **4. Language**
You can set the device's operating language.
-  **5. Key Sounds**
You can turn the sound produced when pressing buttons on or off.
-  **6. Key Vibration**
You can turn vibration feedback when pressing buttons on or off.
-  **7. Key Backlight**
You can turn the keypad backlight on or off for use in dark environments.
-  **8. Flashlight**
You can turn the built-in Flashlight on or off.
-  **9. Device Info**
You can view the device's current hardware version and installed software version.
-  **10. Factory Reset**
You can reset all settings to restore the device to factory defaults.

1. Backlight



You can adjust the screen brightness for better visibility at night or during the day.

IMPORTANT! The backlight has 10 levels, and the default setting is 3.

Low brightness: Saves battery.

High brightness: Helps the screen to be more visible in bright environments.

How to Adjust Backlight?

Navigate to the settings menu in the Expert Menu using the right or left navigation buttons and enter the settings menu with the select button.



Navigate to the Backlight option using the right or left navigation buttons. Increase or decrease the backlight value by one step at a time using the up or down navigation buttons. The selected backlight value appears on the right side of the screen.



Auto-Off Timer Setting

Select the auto-off timer using the select button. Each press of the select button cycles through the backlight auto-off time options: always on, then 5 seconds, 10 seconds, and 20 seconds before it automatically turns off.

IMPORTANT! If you do not press any button during the set period, the backlight will automatically turn off.

5 seconds



10 seconds

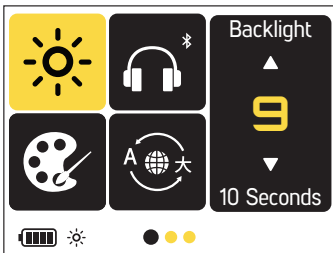

20 seconds

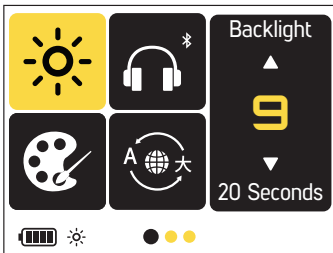

2. Bluetooth®



MAGNETAR 9000 pairs with your headphones via Bluetooth® for a wireless audio experience. Follow the steps below to easily connect your headphones.

How to Pair MAGNETAR 9000 with Bluetooth® Headphones?

Navigate to the Bluetooth® option in the settings menu using the right or left navigation buttons. Press the select button to enter the Bluetooth® screen.



When Bluetooth® is off, turn it on using the select button. After Bluetooth® is activated, wait a few seconds. MAGNETAR 9000 will scan for nearby Bluetooth® headphones and display them in a list.



IMPORTANT! At this point, make sure your headphones are turned on and in pairing mode.

Select the headphones you want to connect from the available list using the up or down navigation buttons. Confirm your selection with the select button.



You can see the selected headphones in the paired area on screen. When your headphones are connected, you can see the Bluetooth® and speaker icons on the display.

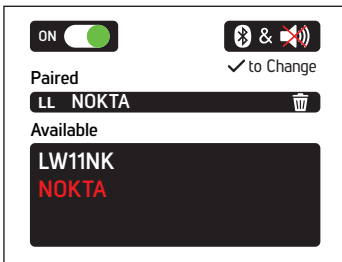

Previously paired headphones will not appear in the list and will connect automatically.

How to Enable the Speaker While Bluetooth® Headphones Are Connected?

Navigate to the top icon on the screen using the up navigation button, and switch to the Bluetooth® and speaker icon area using the right navigation button. Turn the speaker from off to on using the select button.



If you want to clear the saved device list, select the trash icon using the up or down navigation buttons, press the select button to confirm, and wait a few seconds.



IMPORTANT! You can also clear paired headphones using the trash icon and select button while Bluetooth® is off.

IMPORTANT! If your headphones do not appear in the list, make sure they are in pairing mode.

- 🔗 Standard Bluetooth® headphones connected.
- 🔗LL aptX™ Low Latency headphones connected.

When a Bluetooth® headphone is paired and one of the above icons is selected, audio will only be routed through the Bluetooth® headphones.

IMPORTANT! For a better audio experience, make sure your headphones support the LL (Low Latency) feature.

IMPORTANT! When your headphones are connected, audio will automatically be routed to the headphones. If you wish, you can also enable the speaker.

If you experience issues with the Bluetooth® connection, try turning off and back on both MAGNETAR 9000's Bluetooth® feature and your headphones.

IMPORTANT! You can see your connected headphones on the right side of the screen.

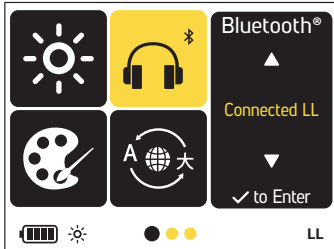

3. Menu Colors



You can customize the screen appearance of your MAGNETAR 9000 according to your usage conditions. Choose from 3 different color themes to find the most suitable one for the ambient lighting conditions.

Daytime Use: In strong sunlight, some colors may be less visible on screen.

Night Use: In darkness, some themes may be hard to see.

Therefore, choose a theme suitable for your environment for the best visibility.

How to Change Menu Colors?

Navigate to the Menu Colors option in the settings menu using the right or left navigation buttons. Select the menu color you want to use with the up or down navigation buttons and press the select button to confirm. The selected menu color appears on the right side of the screen.



IMPORTANT! If you exit without pressing the select button, the selected color theme will not be applied.

4. Language



MAGNETAR 9000 offers 10 different language options, providing flexible usage for users.

IMPORTANT! The device starts with the language set in the factory defaults on first startup. You can change the language setting at any time.

How to Change Language?

Navigate to the Language option in the settings menu using the right or left navigation buttons. Select the language you want to use with the up or down navigation buttons. The selected language appears on the right side of the screen.



5. Key Sounds



The “beep” sound you hear when pressing MAGNETAR 9000’s buttons provides feedback to facilitate your use. This sound is especially helpful in preventing accidental button presses when wearing gloves or in dark environments.

How to Change Key Sounds?

Navigate to the Key Sounds option in the settings menu using the right or left navigation buttons. Select the Key Sounds option you want to use with the up or down navigation buttons. The selected Key Sounds setting appears on the right side of the screen.



Key Sounds works as on and off:



Key Sounds On



Key Sounds Off

6. Key Vibration



You can receive vibration feedback when pressing MAGNETAR 9000’s buttons. This feature facilitates your use by letting you feel each button press. It is especially helpful in preventing accidental button presses when wearing gloves or in dark environments.

How to Change Key Vibration?

Navigate to the Key Vibration option in the settings menu using the right or left navigation buttons. Select the key vibration option you want to use with the up or down navigation buttons. The selected key vibration setting appears on the right side of the screen.



Key Vibration works as on and off:



Key Vibration On



Key Vibration Off

7. Key Backlight



Key Backlight is a feature that makes the buttons easier to see in dark environments. It provides better visibility in night use or low-light environments, enabling easy access to buttons and comfortable operation.

Keypad backlight level is automatically adjusted according to the backlight level.

How to Change Key Backlight?

Navigate to the Key Backlight option in the settings menu using the right or left navigation buttons. Select the key backlight option you want to use with the up or down navigation buttons. The selected key backlight setting appears on the right side of the screen.



Key Backlight works as on and off:



Key Backlight On



Key Backlight Off

8. Flashlight



A feature used to illuminate the Search Coil and the ground in dark or low-light environments. It allows you to see the target area more clearly during nighttime searches. It makes the digging process easier and more efficient.

How to Change Flashlight?

Navigate to the Flashlight option in the settings menu using the right or left navigation buttons. Select the Flashlight option you want to use with the up or down navigation buttons. The selected Flashlight setting appears on the right side of the screen.



Flashlight works as on and off:



Flashlight On



Flashlight Off

9. Device Info



MAGNETAR 9000 stores version information, real-time operating time, and total operating time in its memory and shares this information with users for a unique experience.

MAGNETAR 9000 records how long it has been running from the moment it is turned on. You can view the usage time in Year/Month/Day/Hour format.

You can view your device's software version number in the Device Info section.

How to View Usage Time and Device Info?

Navigate to the Device Info option in the settings menu using the right or left navigation buttons. Select the information you want to view using the up or down navigation buttons. The selected information appears on the right side of the screen.



10. Factory Reset



This option restores your device to its original factory settings, resetting all personal settings and deleting saved data. As a result, all of the following settings are restored to factory default values:



Mode



Ground



Noise Cancel



Ground Balance



Sensitivity



Volume



Threshold Volume



Threshold Frequency



Audio Filter



Stabilizer



Target Volume



Backlight



Bluetooth®



Menu Colors



Key Sounds



Key Vibration



Key Backlight



Flashlight

How to Restore Factory Settings?

Navigate to the Factory Reset option in the settings menu using the right or left navigation buttons. Press and hold the select button for 3 seconds to restore MAGNETAR 9000 to factory settings.



SOFTWARE UPDATE

MAGNETAR 9000 has software update capability. Software updates and related instructions made available after MAGNETAR 9000's market launch will be announced on the product's website.

ERROR CODES

The device will shut down shortly after one of the below messages is displayed on screen:

F001: Indicates a system error. The device will shut down automatically. Contact your authorized Nokta service center.

F002: Indicates that a corrupted file was loaded or the software update could not be completed. Connect the device to your computer using the update cable and restart the update using the verified update file published by Nokta. If the issue persists after multiple attempts, contact your authorized Nokta service center.

F003: Indicates a system error. The device will shut down automatically. Contact your authorized Nokta service center.

F080: Indicates a system error. The device will shut down automatically. Contact your authorized Nokta service center.

No Coil Detected! Indicates that the search coil could not be detected by the device. The device will shut down automatically. Check the search coil connection. If the issue persists, contact your authorized Nokta service center.

WARNING MESSAGES

Overload! Indicates that the search coil is overloaded. The device cannot detect targets while this warning is displayed. The warning will disappear automatically when you move the search coil away from large metal objects.

Low Battery! Indicates that the battery level is low. Charge your device.

Low Battery. Cannot Update: The battery level is too low for updating. Charge your device before performing an update.

RECOVERY

Recovery: If an unexpected power interruption occurs during an update, the device enters recovery mode. This message will appear on the screen. Do not turn off the device and wait for the recovery process to complete.

Recovery Fail – Restart: This message appears if the recovery process cannot be completed within 180 seconds. Press and hold the power button for 10 seconds to turn off the device. Then turn it back on; the recovery process will restart automatically. If the issue persists after multiple attempts, contact your authorized Nokta service center.

HEADPHONE INFORMATION

MAGNETAR 9000 comes with Bluetooth® headphones. The Bluetooth® headphones are not waterproof and should not come into contact with water.

Bluetooth® connectivity works as long as the device's system box is not submerged. In other words, you can use wireless headphones during shallow water searches while the Search Coil is submerged. However, remember that the wireless headphones must not come into contact with water.

When the entire device is to be submerged, wireless connectivity will not work. In this case, you will need to obtain the Nokta Waterproof Headphones, sold as optional accessories, which can be used both on land and underwater. If you are only submerging the system box and not the headphones, you can also choose our Nokta Koss headphones with waterproof connectors.

For land use, if you wish to use MAGNETAR 9000 with your own wired headphones, you can purchase the optional headphone adapter.



TECHNICAL SPECIFICATIONS

Operating Principle: Advanced Pulse Induction

Mode: Maximum / Standard / Deep

Ground: Regular / Tough / Extreme

Ground Balance: Auto / Semi Auto / Manual

Operating Menus: Easy and Expert

Search Coils

MAGNETAR 9000: MG37-DRC 14.5" x 13" / 37 cm x 34 cm

MAGNETAR 9000: MG29-DRC 11" / 29 cm x 21 cm

Audio Output: Built-in speaker, Bluetooth®, and 1/4" (6.3 mm) headphone jack

Display: Full color, 320 × 240 pixels, 49mm × 37mm (1.9" × 1.5")

Length: 150cm (59") – 72cm (28") collapsible

Weight: 5.3lbs / 2.4 kg (with 11-inch Search Coil and battery),

6.2lbs / 2.8 kg (with 14-inch Search Coil and battery)

Operating Temperature Range: 32°F to 122°F (0°C to 50°C)

Operating Humidity Range: Up to 95% non-condensing

Storage Temperature Range: -4°F to 140°F (-20°C to 60°C)

Waterproof Rating: IP68, up to 10ft (3 meters)

Warranty: 3 years

Custom User Profiles: Yes

Adjustable Threshold Volume: Yes

Adjustable Threshold Frequency: Yes

Noise Cancel: Yes

Key Vibration: Yes

Key Sounds: Yes

Key Backlight: Yes

Sensitivity Setting: 20 levels

Display: Color LCD

Backlight: Yes

Flashlight: Yes

Battery Technical Specifications

Type: Rechargeable lithium-ion battery

Output Voltage Lithium-Ion: 7.2V DC

Lithium-ion battery capacity: 48Wh

Operating Time: 7-10 hours

TECHNICAL SPECIFICATIONS

Lithium-ion battery weight: 270g (9.6oz)

Battery Operating Temperature: 32°F to 122°F (0°C to 50°C)

Battery Storage Temperature: 23°F to 158°F (-5°C to 70°C)

Charger Technical Specifications

Operating Temperature: 32°F to 113°F (0°C to 45°C)

Storage Temperature: -22°F to 176°F (-30°C to 80°C)

Input Voltage: 12 to 30 VDC

USB Output Current: 500 mA

*Bluetooth® brand and logos are registered trademarks owned by Bluetooth® SIG, Inc.
Qualcomm® aptX™ is a product of Qualcomm Technologies, Inc.*

*Nokta Detectors reserves the right to change product specifications, designs,
and accessories without prior notice.*



For Consumers within the European Union: Do not dispose of this equipment in general household waste. The crossed wheeled bin symbol on this equipment indicates this unit should not be disposed of in general household waste, but recycled in compliance with local government regulations and environmental requirements.



FCC STATEMENT

This device complies with Part 15 of the FCC Rules. Operation is subject to the following two conditions: (1) this device may not cause harmful interference, and (2) this device must accept any interference received, including interference that may cause undesired operation.







www.noktadetectors.com