

The LEGEND²

High-Performance Metal Detector!

USER MANUAL



READ CAREFULLY BEFORE OPERATION OF THE DEVICE!

LEGAL DISCLAIMERS

Comply with applicable laws and regulations governing use of metal detectors while using this detector. Do not use the detector without authorization in protected or archeological sites. Do not use this detector around unexploded ordnance or in restricted military zones without authorization. Notify appropriate authorities with details of any historical or culturally significant artifacts you find.

WARNINGS

The LEGEND 2 is a state-of-the-art electronic device. Do not assemble or operate the device before reading the user manual.

Do not store the device and search coil under extremely low or high temperatures for extended periods. (Storage Temperature: - 20°C to +45°C / - 4°F to +113°F)

The device features an IP68 waterproof rating, allowing submersion up to 5 meters (16 ft), excluding the Bluetooth® headphones.

Pay attention to the items below after using the device especially under salty water:

1. Rinse the system box, shaft, and coil with tap water, making sure all saltwater is fully removed from the connectors.
2. Do not use any chemicals for cleaning and/or for any other purposes.
3. Wipe the screen and the shaft dry with a soft, non-scratch cloth.

Protect the detector from impact during use. When shipping, place it in the original carton and secure it with shock-resistant packaging.

The LEGEND 2 metal detector may only be disassembled and repaired by Nokta Authorized Service Centers. Unauthorized disassembly/intrusion into the metal detector control housing for any reason voids the warranty.

IMPORTANT!

Do not use the device indoors, where surrounding metals may cause continuous target signals. Use only in open outdoor areas.

Keep other detectors and electromagnetic devices a minimum of 10 m (30 ft) from the device.

Do not carry any metal objects while using the device. Keep the device away from your shoes while walking. Metal on your body or inside your shoes may be detected as targets.

CONTENTS

ASSEMBLY _____	: 3-6
INTRODUCTION TO THE DEVICE _____	: 7
DISPLAY _____	: 8
BATTERY INFORMATION _____	: 9
CORRECT USE _____	: 10
QUICK GUIDE _____	: 11
COMMON AND MODE-BASED SETTINGS _____	: 11-12
SEARCH MODES _____	: 12-14
USER PROFILE _____	: 14-15
MUTE FUNCTION _____	: 15
TARGET ID _____	: 16
GROUND BALANCE _____	: 16-18
PINPOINT _____	: 18
FERROCHECK™ _____	: 19
MINERALIZATION INDICATOR _____	: 20
TARGET DEPTH _____	: 20
QUICK SETTINGS _____	: 20-25
1. Sensitivity _____	: 21
2. Frequency _____	: 22
3. Discrimination Patterns _____	: 23
4. Recovery Speed _____	: 24
5. Bottle Cap Rejection _____	: 24
5.1 Iron Rejection in Relic Mode _____	: 24
6. Iron Filter _____	: 25
7. Stability in Beach Mode _____	: 25

CONTENTS (Continued)

SETTINGS	: 25-30
1. Volume Level	: 26
2. Frequency Shift	: 26-27
3. Ground Suppressor	: 27
4. Deep Target Identification	: 27
5. Notch (Accepting and Rejecting IDs)	: 28-29
6. Screen and Keypad Backlight	: 29
7. Vibration	: 30
8. LED Flashlight	: 30
AUDIO OPTIONS	: 30-31
1. Speaker	: 31
2. Bone Conduction Headphones	: 31
3. Bluetooth® Headphones	: 31
4. Multiple Audio Output	: 31
5. Wired Headphones	: 31
SUB-SETTINGS	: 32-40
1. Number of Tones	: 32-33
2. Tone Volume	: 34
3. Tone Frequency	: 35-36
4. Tone Break	: 36-37
5. Threshold Level	: 38
6. Threshold Frequency	: 39
7. Audio Gain	: 39
8. Clock and Usage Duration	: 40
9. FerroCheck™ / Mineralization Option	: 40
WARNING MESSAGES	: 41
REVERTING BACK TO FACTORY DEFAULTS	: 41
SOFTWARE UPDATE	: 41
HEADPHONES	: 41
TECHNICAL SPECIFICATIONS	: 42
RECOMMENDED ACCESSORIES	: 43

ASSEMBLY

1 After inserting the washers onto the lower shaft, attach the lower shaft to the search coil and secure it by tightening the screw. Do not overtighten.

2 Open the lever latches to connect the middle shaft to the upper and lower shafts. Adjust the length to your height, tighten the side screws, and close the latches to secure.

IMPORTANT! During assembly, make sure that the red lines on the shafts are aligned to overlap, as shown in below.

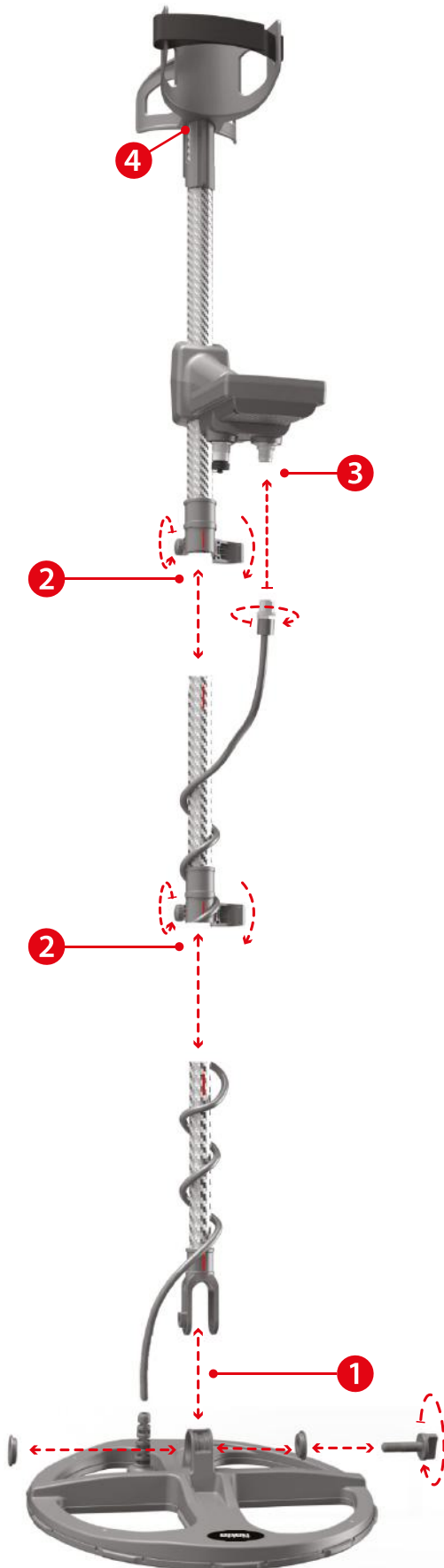

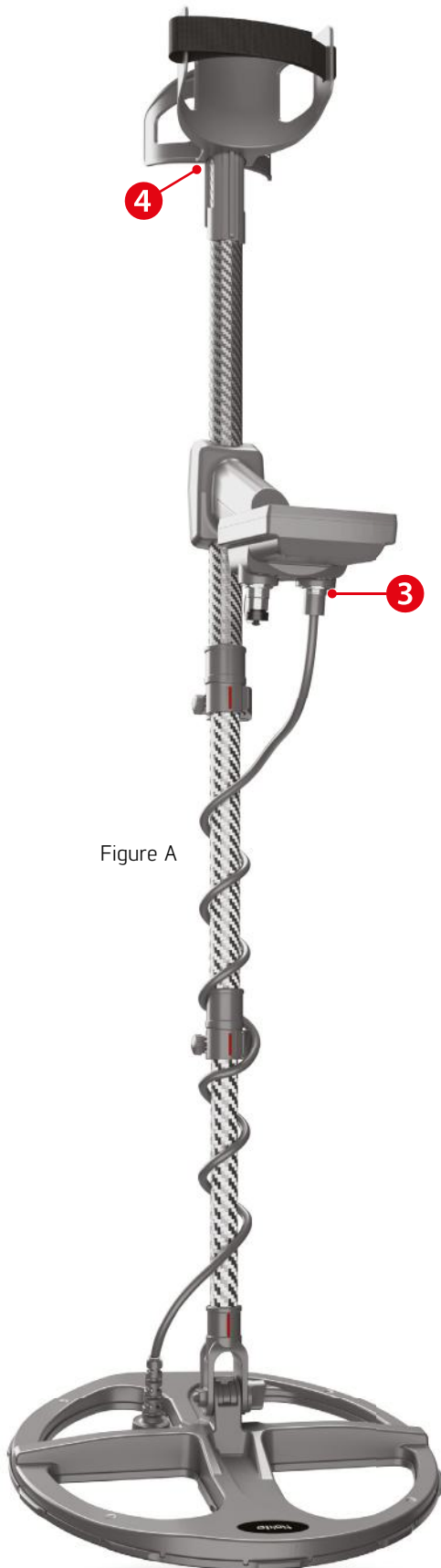

Figure A

3 Wind the search coil cable around the shaft without overstretching (Figure A), then plug the connector into the search coil input socket on the system box (Figure B) and secure it by tightening the nut until you hear clicks.

Figure B:



4 If you want to adjust the armrest, open the latch. Once it reaches the desired height, close the latch as shown in (Figure C) to secure it.

Figure C:



Attach the armrest strap as shown in the picture (Figure D) and tighten it according to the width of your arm.

Figure D:





IMPORTANT! When the red lines on the shafts are aligned and the shafts are set to their shortest position, the search coil becomes rotatable. By rotating and folding the search coil, you can place the detector in a compact carrying position.

IMPORTANT! To prepare the detector for use from the compact position, the system box and the search coil must be aligned in the same direction, and the red lines on the shafts must be fully aligned. Otherwise, the shafts cannot be extended.

IMPORTANT! The flat section on the rear of the detector shafts ensures a tight fit.

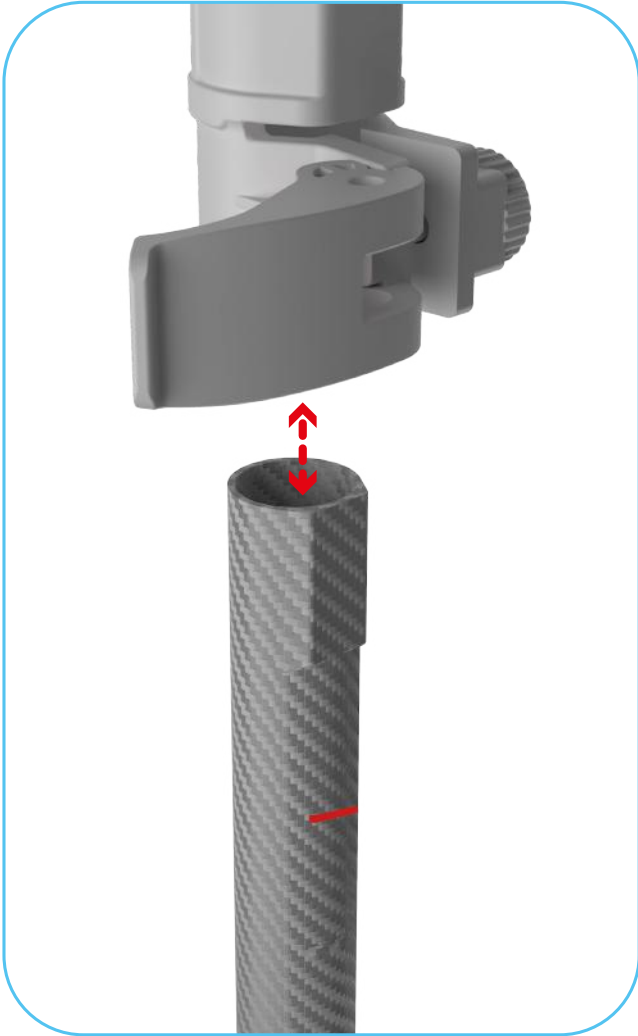

IMPORTANT! The red lines on the rear of the shafts indicate the maximum length to which the shafts can be extended. Do not exceed this limit.

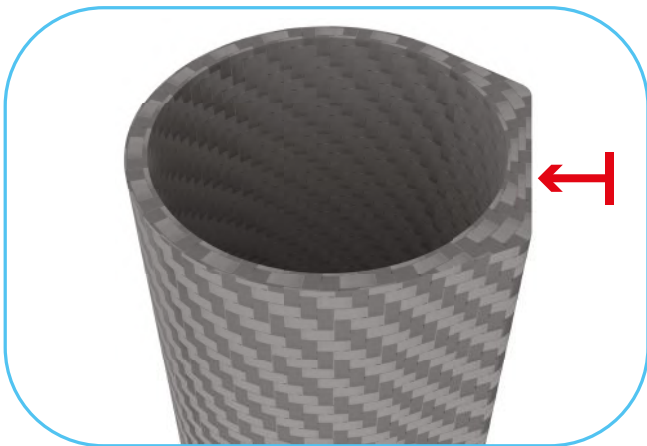

INTRODUCTION TO THE DEVICE



1. LCD Screen

2. Power / Settings Button

Press and hold the Power / Settings button for 2 seconds to turn the device on. Press once to enter or exit settings. To turn the device off, press and hold the Power / Settings button.

Note : While in settings, pressing and holding the Power / Settings button will not turn the device off.

3. Ground Balance Button

Press the Ground Balance button once to enter or exit the ground balance menu. Press and hold the Ground Balance button to perform automatic ground balancing.

4. Right Button

On the main screen, the Right button navigates between modes, while in the settings menu, it navigates through the settings options.

5. Up and Down Buttons

Use the Up and Down buttons to adjust the selected quick setting on the main screen or to change any setting value in the settings menu.

6. Left Button

On the main screen, use the Left button to switch between user profiles. Press and hold to save or delete a profile. In the settings menu, use it to navigate between options.

7. Pinpoint & Accept/Reject Button

On the main screen, the Pinpoint & Accept/Reject button activates the Pinpoint mode. Press once to enter or exit Pinpoint. Functions of this button in other settings are described in their respective sections.

8. Quick Settings / Mute Button

On the main screen, press the Quick Settings / Mute button briefly to enter or exit Quick Settings. Press and hold to mute or unmute the device.

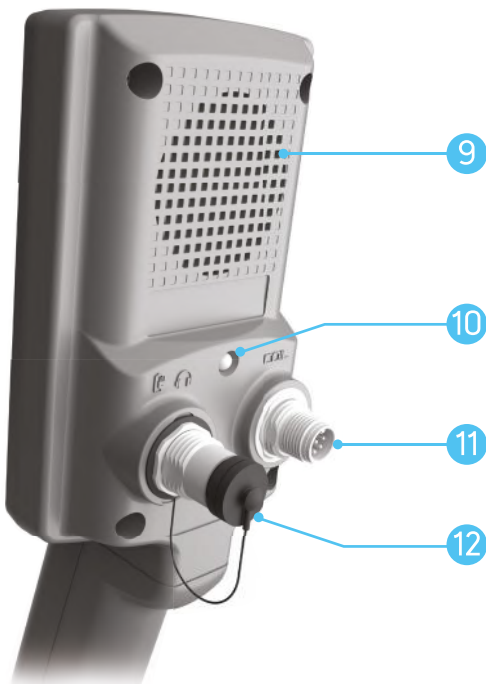

9. Speaker

10. LED Flashlight

11. Search Coil Input Socket

12. Wired Headphones, Bone Conduction Headphones and Charging Input Socket

IMPORTANT! Always keep the socket closed with the screw cap when no headphones or charging cable are connected.

DISPLAY

- | | |
|---|------------------------------|
| 1. Info Bar | 9. Charging LED |
| 2. Search Modes | 10. Clock and Usage Duration |
| 3. Target ID Scale and Discrimination Pattern | 11. User Profiles |
| 4. Quick Settings | 12. Target ID |
| 5. Sensitivity Indicator | 13. Depth Indicator |
| 6. Operating Frequency | 14. Audio Options |
| 7. FerroCheck™ Bar | 15. Auxiliary Indicator |
| 8. Settings | |

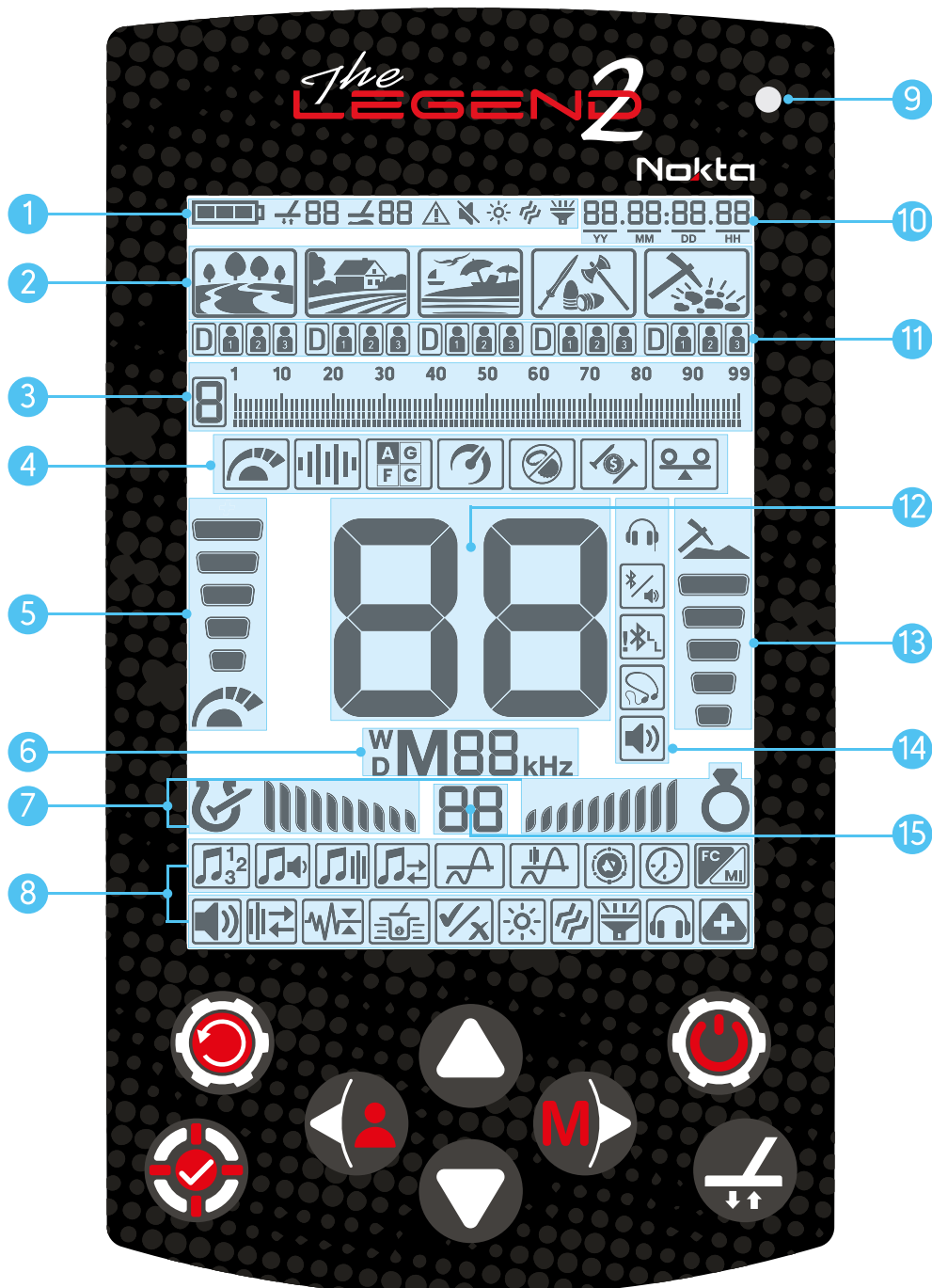

BATTERY INFORMATION

The LEGEND 2 has an internal 6700 mAh Lithium-ion battery.

Battery runtime varies between 8 and 20 hours. Factors such as operating frequency, usage of speaker or wired/wireless headphones, display backlight, LED flashlight etc. will affect battery runtime.

Charging

Charge The LEGEND 2 before initial use. Charging an empty battery will take approximately 5-6 hours.

To charge the battery, insert one of the ends of the cable supplied with the device to the wired headphones / charger input socket and the other end to the charging adapter.

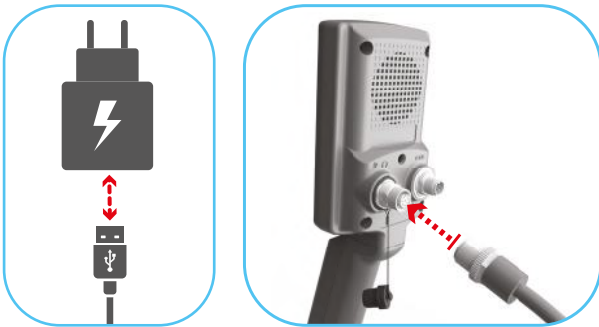

Use a standard 5V 2A (minimum) USB power adapter to charge the device. Charging via a PC USB port may take longer.

Low Battery Level

The battery icon on the display indicates the battery level. As the charge decreases, the bars inside the icon decrease accordingly. When the battery is depleted, 'Lo' appears on the display and the device powers off.

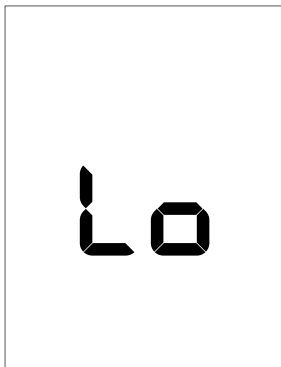

BATTERY WARNINGS

Do not expose the device to extreme temperatures (for example a car's trunk or glove compartment).

Do not charge the battery in temperatures over 35° C (95° F) or below 0° C (32° F).

The LEGEND 2 battery can only be replaced by Nokta Detectors or its authorized service centers.

WATERPROOF REPLACEABLE SPARE BATTERY

This optional battery, sold separately, can replace the internal Li-Ion battery when it is depleted and you are unable to recharge it.

You can attach the spare battery easily as shown in the picture.



When you are using the spare battery, you cannot plug any wired headphones to the device.

You can charge the spare battery easily using the charger it comes with.

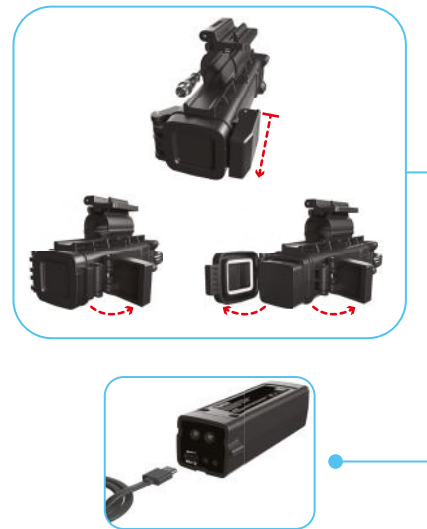

Operating with a Powerbank

You can also power and charge the battery with a powerbank. To do this, just insert one of the ends of the cable supplied with the charger to the wired headphones / charger input socket and the other end to the powerbank. Please note that you will not be able to attach wired headphones to the device when a powerbank is attached to the device.

IMPORTANT! Do NOT use the detector underwater while connected to a powerbank.

CORRECT USE

Shaft height is wrong

Adjust the shaft to your height to ensure comfortable use and reduce fatigue during searching.

While detecting, the device may detect false signals from metal objects you carry or from shoes containing metal.

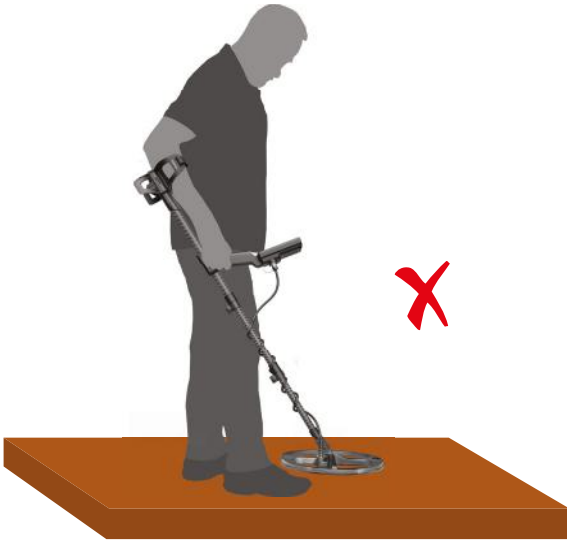

Shaft height is correct

Adjust the height of the shaft so that you are standing in an upright position, your arm is relaxed and the search coil is approximately 5 cm (~2") above the ground.

While detecting, the device will not detect false signals from metal objects you carry or from shoes containing metal.



CORRECT WAY OF SWEEPING

Wrong search coil angle



Correct search coil angle



Incorrect way of sweeping

It is important to keep the search coil parallel to the ground in order to get accurate results.



Correct way of sweeping

The search coil must be parallel to the ground at all times.

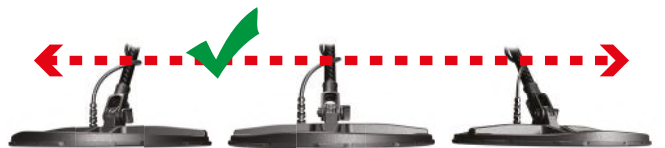

QUICK GUIDE

1. Assemble the device as per the instructions on page 3-6.
2. Press and hold the Power / Settings button for 2 seconds to turn on the device. The loading message 'L2' will appear on the screen, and the software version will be displayed in the upper-right corner.

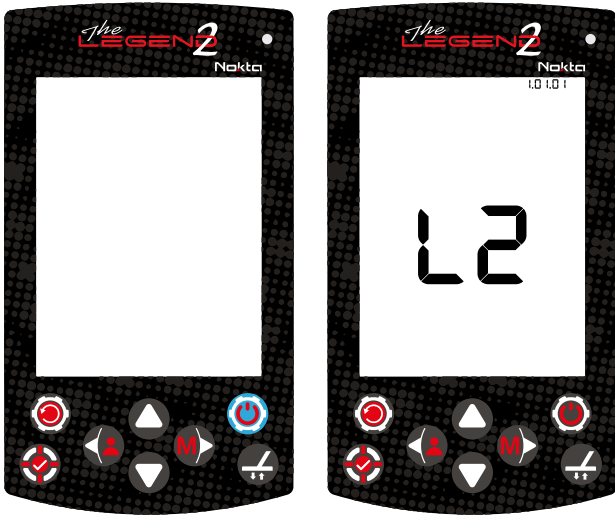

3. When the device is turned on, it will start in the Park mode and in Multi frequency. You can change the mode based on ground conditions. You can find more details on search modes and frequencies further in this manual.

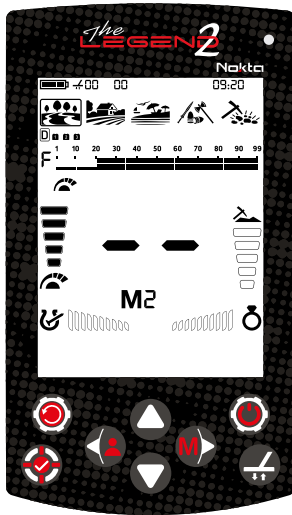

4. You can increase the selected quick setting, which is the sensitivity setting, if needed. Increasing the sensitivity will offer you greater depth. However, if the surroundings or the ground cause excessive noise in the device, you need to lower the sensitivity setting.

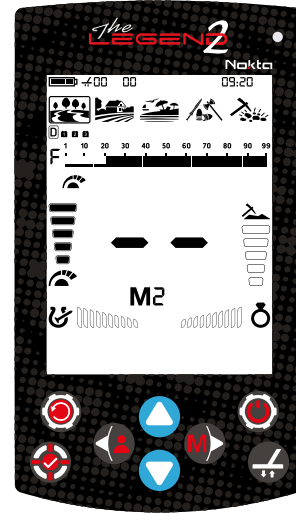

5. You can start detecting!

COMMON AND MODE-BASED SETTINGS

Certain settings are common to all modes; changes in these settings will take effect in all modes.

Most of the settings are mode based and they only affect the mode currently selected; changes made in one mode do not affect the others.

Common settings and mode-based settings are marked as below throughout the manual:

Park Field Beach

P	F	B
Relic	R	Gold

Common Settings



Sensitivity



Volume



Backlight



Vibration



FerroCheck™ / Mineralization Indicator



Bluetooth®



LED Flashlight

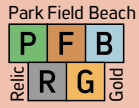

Mode-Based Settings



Ground Balance



Custom Discrimination Mode



Frequency



Recovery Speed



Bottle Cap Rejection /
Iron Rejection in Relic Mode



Iron Filter



Stability in Beach Mode



Frequency Shift



Ground Suppressor



Deep Target Identification



Number of Tones



Tone Volume



Tone Frequency



Tone Break



Threshold Level



Threshold Frequency



Audio Gain



Notch (Accepting and Rejecting IDs)

SEARCH MODES

The LEGEND 2 has 5 search modes designed for different terrains and targets.

Navigating Through Search Modes

During the search, you can switch between modes on the main screen using the Right button. The selected mode will be shown within a frame.

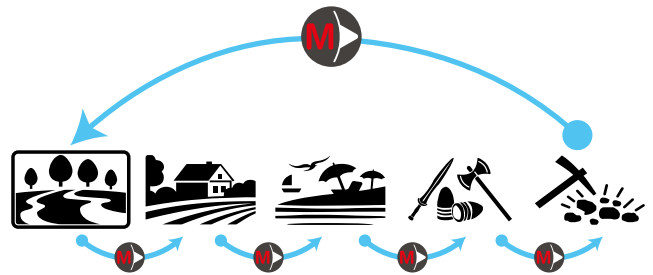

PARK

Designed for coin and jewelry hunting in urban areas and parks where there are lots of modern trash (aluminum foil, pull-tabs, bottle caps etc.) present.

This mode is optimized for detecting medium and large coins and jewelry. In the factory default setting, the custom discrimination pattern excludes many targets, such as iron and aluminum foil. Target IDs on the ID scale, including 21, are set to "off" to allow searching without detecting these targets.

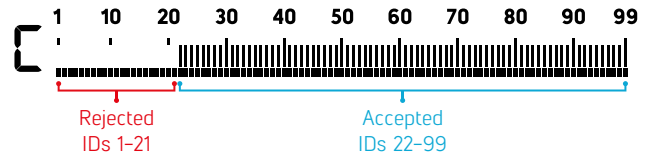

Aluminum foil typically generates a Target ID of 21. However, depending on the shape, its ID can go up to 34.

All single frequencies as well as Multi frequency can be used in this mode. Based on target type, you can choose the frequency you want. Multi frequency in Park mode will allow for maximum depth and separation. Thus, a slight noise can be experienced.

The Park mode is set to Recovery Speed 5 and 2 tones by default. You can change the Recovery Speed as well as the number of tones manually if needed.

The FerroCheck™ bar on the screen shows the ferrous/non-ferrous ratio of the target and thus plays an important role in identifying trash metals. Therefore, when a target is detected while in Park mode, the FerroCheck™ bar should be observed in addition to the Target ID.



FIELD

Recommended for coin and relic hunting in pasture and cropped/plowed fields.

In these areas, iron-containing debris and coke fragments are commonly found. To make it easier to detect coins and relics among such debris, the Target ID scale in the custom discrimination pattern is set to "off," including 21, in the factory default settings.

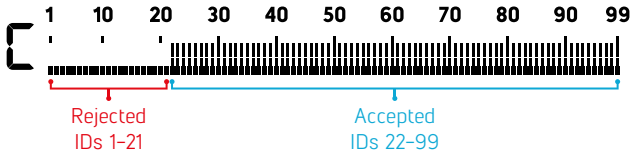

In this mode, all single and multi frequencies operate. When Multi frequency is selected, the device provides maximum depth and discrimination capability. The Field mode comes from the factory preset with a Detection Speed of 5 and a Target Tone Count of 2.

In Field mode, the first tone break point is 21 for all tone options. In Park mode, the first tone break point is 20 for all tone options.

The ID resolution of IDs 21-25 is different in Park versus the Field mode. You may get a different ID in each mode for targets that fall within this ID range.

Park and Field modes offer 3 different Multi frequencies as Multi-1 (M1), Multi-2 (M2) and Multi-3 (M3). For details, please refer to the Frequency section.

In Park and Field mode, different algorithms are used. On trashy sites, M3 Multi-Frequency is recommended. When a target is isolated underground, the ID will be the same in both modes. However, if the target is next to trash, such as aluminum foil, Multi 3 in Park mode will provide a more accurate ID.



BEACH

This mode is optimized for use on dry or wet beach sand and for underwater use up to 5 m (16 ft).

Salt in beach sand and seawater makes the ground and water highly conductive, generating noise and false signals. Single-frequency detectors cannot operate effectively in these conditions, while multi frequency detectors reduce noise and provide maximum performance.

For these reasons, single frequencies cannot be used in the Beach mode. When Beach mode is selected, the device automatically switches to Multi frequency and single frequencies cannot be selected. In this mode only, the Multi frequency has 2 options: Wet sand/underwater (MW) or dry sand with very low salinity (MD). When you change the frequency in Beach mode, you switch between MW and MD.

If the sand you are detecting on is dry but has high salinity, use the MW option. To determine salinity, move the search coil over the sand in All Metal Discrimination Pattern (see Discrimination Patterns) and check the ID of the sand. If the ID is higher than 4, select MW instead of MD. You can also enable the mineralization indicator to measure the salinity of the search area.

The ground balance and ID stability has been optimized for different conditions and will vary for each option. In wet beach sand, MW Multi frequency will generate accurate IDs but if you switch to MD, the IDs may be wrong. Similarly, in dry sand with low salinity, you can ground balance the detector in MD but if you switch to MW, you may not be able to ground balance.

The Beach mode is set to Recovery Speed 6 and 2 tones by default.

Black Sand

Some beaches are covered with black sand which contains natural iron. These types of beaches make metal detection almost impossible. Beach mode senses black sand automatically and displays a warning icon on the top of the screen in the Info Bar.

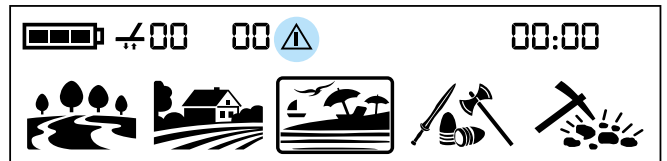

IMPORTANT! After submerging the device underwater and taking it out, water may enter the speaker cover, causing muffled audio. This is normal. Gently shake the device to remove the water from the speaker cover, and the audio will return to normal.



RELIC

Very deep targets may have values close to the surrounding soil and therefore may not be detected. Relic mode allows you to detect targets at depths that cannot be detected in other modes.

This mode resets the ground balance of the soil, allowing the detector to detect deep coins and large masses. However, in this mode, targets at the limit of detection may not provide an ID or their IDs may be unstable.

Ground balancing is very important in Relic mode. To use Relic mode most efficiently, perform ground balancing first when the mode is selected. In addition, a second ground balance feature is available only in Relic mode. After performing the initial ground balance, you can eliminate the effect of mineralized stones, referred to as hot rocks, in the search area by using the second ground balance on those stones.

Relic mode provides high performance on some beaches. As with other terrains, it is recommended to use the All Metal Discrimination Pattern when searching on the beach. Signals with IDs 20 or 99 may originate from the beach in the area you are detecting. By disabling these IDs using the ID Notch (ID Reject) feature, Relic mode can be used on the beach without interference.

Relic mode comes factory-set with a Detection Speed of 5 and a Target Tone Number of 1.

In this mode, tone options have been removed. The audio frequency changes proportionally to the signal strength. Additionally, by enabling the Iron Bias feature, you can distinguish iron-containing targets that are close to the ground surface (see Iron Bias Feature in Relic Mode).



GOLD

This mode is optimized for use on mineralized goldfields.

In this mode, the factory setting includes an audible threshold tone. The volume and the frequency of the audio alert emitted when a target is detected, vary proportionally to the strength of the target signal. Gold mode is ideal for detecting shallow and small gold nuggets as well as deeper larger nuggets in mineralized ground.

You can only use the higher single frequencies (20 kHz and 40 kHz) and the Multi frequency in this mode. In highly mineralized ground, detectors receive a lot of false signals. In addition, there are mineralized rocks -commonly referred to as hot rocks- present in goldfields. Therefore, Multi frequency in this mode offers convenient detection by minimizing the effects of these mineralized rocks and ground.

Gold mode is set to Recovery Speed 5 and 1 tone by default.

USER PROFILE



The LEGEND 2, offers the ability to save the settings you make during searching to three different user profiles in each mode. User profiles are available separately for each search mode.

This is a great feature for users to preserve their optimized settings. They can easily and quickly reuse the saved settings later on.

User Profile Menu



The User Profiles of the search mode are displayed in the section below the search mode.

All user profiles have the default settings of The LEGEND 2.

The Default (D) User Profile is preselected.

The D User Profile automatically saves the changes made by the user. Since the automatic save feature is predefined, users cannot manually save settings to this profile. If desired, the automatically saved settings can be restored to factory defaults by performing the "Clear Profile" operation.

Changing the Active User Profile

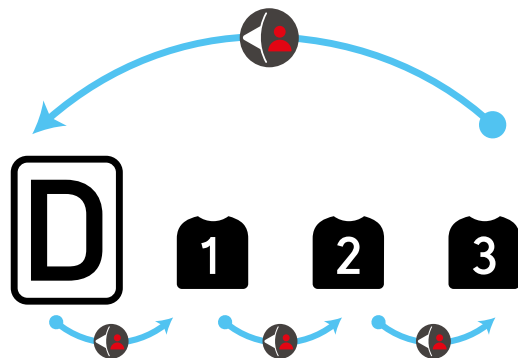

You can change the Active User Profile on the main screen by pressing the Left button once. The Active User Profile is framed.

When the profile is changed, the selected profile information is also displayed in the Auxiliary Indicator. This text is automatically cleared after a short time.

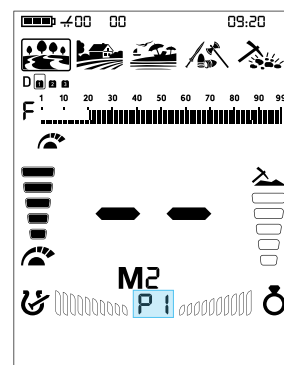

Saving a User Profile

If you want to preserve the settings you used after searching in a specific area, you can save these settings to any User Profile.

1. After selecting a user profile in the User Profile menu, press and hold the Left button for 2.5 seconds to save your settings to the selected profile.

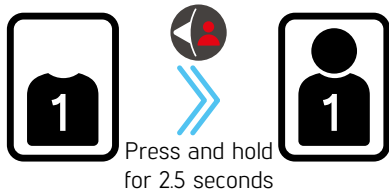

After the profile is saved, a head icon appears inside the User Profile icon.

Along with the head icon, the text SP (Save Profile) is displayed in the Auxiliary Indicator.

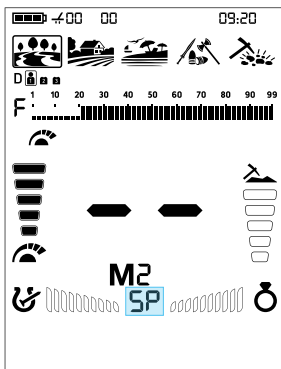

If the profile has been saved previously, the coil icon is already displayed. When a new save is made over the existing profile, the SP letters shown in the Auxiliary Indicator mean that the overwrite has been completed successfully.

IMPORTANT! Common settings are saved automatically. User Profiles save mode-specific preferences.

Clearing the User Profile

1. In the User Profile menu, use the Left button to select the saved profile you want to clear.

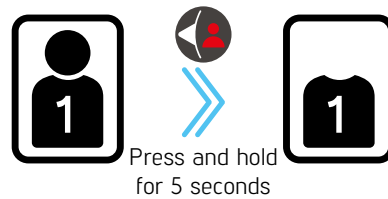

2. Clear the user profile by pressing and holding the Left button for 5 seconds. The head icon in the user profile will disappear.

To clear the profile, press and hold the Left directional button. After 2.5 seconds, the SP letters are displayed in the Auxiliary Indicator. If you continue holding the button without releasing it, the CP (Clear Profile) letters appear after 5 seconds. The disappearance of the coil icon together with the CP letters indicate that the profile has been erased. You can then release the button.

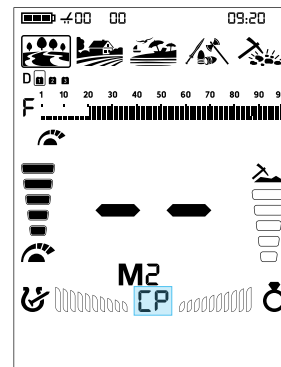

You can save your favorite settings for different targets and sites with the user profile in each mode, allowing you to create a total of 15 different detector setting sets across all modes.

MUTE FUNCTION

On the main screen, press and hold the Quick Settings button to mute the device.

The mute icon will appear in the Info Bar at the top. You can turn the sound on by pressing and holding the Quick Settings button.

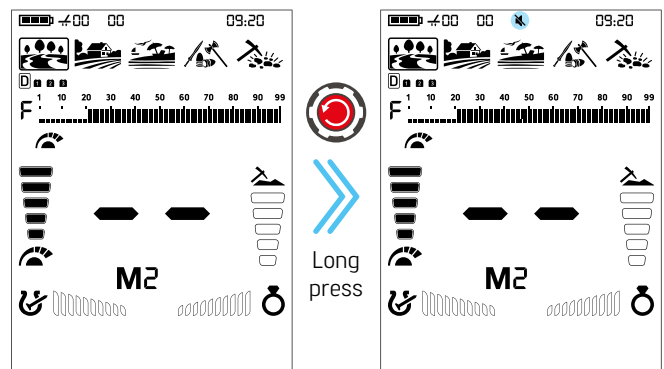

IMPORTANT! When the volume level is set to 0, the muted icon is also displayed.

TARGET ID

Target ID is the number produced by the metal detector based on the conductivity of the metals and gives an idea to the user about what the target may be.

Target ID is shown with two digits on the display and ranges between 01 and 99.

The LEGEND 2's Target ID scale consists of 99 lines, each of which represents 1 Target ID.

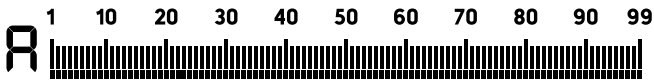

In addition to showing the Target ID in the middle of the screen, the ID is also marked with a small cursor under the ID scale.

Ferrous range is 1-20.

Non-ferrous range is 21-99.

In some cases, the device may produce multiple IDs for the same target. In other words, the IDs may be jumpy. This may result from several factors. Target orientation, depth, purity of the metal, corrosion, mineralization level of the soil etc. Even the direction of the search coil swing may cause the device to generate multiple IDs.

In some cases, the device may fail to provide any ID. The device needs to receive a strong and a clear signal from the target in order to provide an ID. Therefore, it may not be able to provide an ID for targets at fringe depths or smaller targets even if the device detects them.

Keep in mind that Target IDs are "probable", in other words, estimated values and it would not be possible to know the properties of a buried object exactly until it is dug out.

IDs of non-ferrous metals such as copper, silver, aluminum and lead are high. Target ID range of gold is wide and may fall within the same range of metal wastes such as iron, foil, screw caps, and pull tabs. Therefore, if you are looking for gold targets, digging out some trash metals is expected.

Coins searched throughout the world are made of different metals and in different sizes in different geographical locations and historical eras. Therefore, in order to learn the Target IDs of the coins in a specific zone, it is suggested to perform a test with the samples of such coins, if possible.

It may take some time and experience to make best use of the Target ID feature in your search area. Different brands and models of detectors produce different Target ID numbers.

IMPORTANT! Keep in mind, large targets will ID higher than expected, even though they may be of lower conductance.

GROUND BALANCE

The LEGEND 2 is designed to work without ground balancing on most terrains. However, for experienced users and on highly mineralized grounds, ground balancing will bring extra depth and stability to the device.

Ground balance can be performed in three ways with The LEGEND 2: Automatic, Manual and Tracking.

Ground balance only affects the mode currently selected; changes made in one mode do not affect the others.

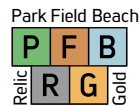

The device can perform ground balance within the range of 00-99 in all modes and 00-20 in the Beach mode MW Multi frequency. The ground balance must be performed separately for the Beach MD Multi frequency and for Beach MW Multi frequency options. The ground balance done in MD will not work for MW and vice versa.

On The LEGEND 2 device, you can view both the ground balance level and the level calculated based on real-time ground measurement in the information area of the display. The real-time ground balance measurement is shown to inform the user. The ground balance level, on the other hand, indicates the ground balance value at which the device is operating.

A screenshot of the LEGEND 2 display. The top bar shows battery, signal strength, and time (09:20). Below that are icons for various modes. The main display area shows a Target ID scale with a cursor under '1'. To the left of the scale, the text 'The ground balance level at which the device is operating' is displayed. To the right, the text 'The real-time ground measurement level shown for informational purposes' is displayed.

Automatic Ground Balance

Automatic ground balance is performed as follows in all search modes:

1. Find a spot where there is no metal.
2. Hold the Ground Balance button down. The ground balance icon will start blinking in the Info Bar at the top and the ground balance value will be displayed in the middle of the screen. If no ground balancing has been performed before, this value will always be zero (0).

A diagram illustrating the steps to perform automatic ground balance. It shows two screenshots of the LEGEND 2 display. The first screenshot shows the 'M2' mode selected and a ground balance icon (a circle with a cross) in the top right corner. A blue arrow points to the right, indicating the next step. The second screenshot shows the ground balance icon blinking and the ground balance value '0' displayed in the center of the screen. Below the screenshots, the text 'Hold down' is written next to a blue arrow pointing to the right.



3. Start pumping the search coil up and down from about 15-20 cm (~6"- 8") above the ground down to 3 cm (~1") off the ground with smooth movements and keeping it parallel to the ground.

4. Continue until the audio reduces in response to the ground. Based on ground conditions, it usually takes about 2-4 pumps for the ground balance to be completed.

5. The ground balance value is displayed on the screen in the ID area and in the Info Bar. In order to ensure that the ground balance is proper, ground balance at least 2-3 times and check the ground balance values on the display. In general, the difference between the values shall not be higher than 1-2 numbers.

6. If you cannot ground balance, it means that either the ground is too conductive or not mineralized or there is a target right below the search coil. In such a case, retry ground balancing at a different spot.

Manual Ground Balance

Allows you to manually modify the ground balance value. It is not preferred mostly because it takes time. However, it is the preferred option in cases where a successful ground balance cannot be performed using other methods or minor corrections are required to the automatic balance.

1. Find a clear spot without metals.
2. Press the Ground Balance button once. The device will switch to the ground balance screen. The current ground balance value is displayed in the center of the screen. If ground balance has not been performed previously, this value will always be zero (0).

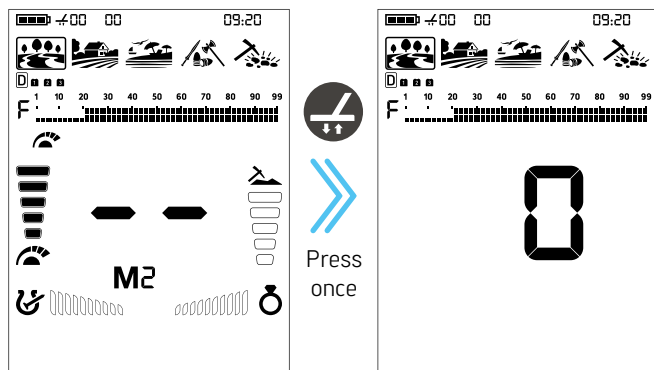

3. You need to listen to the sounds coming from the ground in order to perform manual ground balance. Pump the search coil up and down from about 15-20 cm (~6"- 8") above the ground down to 3 cm (~1") off the ground with smooth movements and keeping it parallel to the ground.

4. If you are getting a low tone while pumping the coil, it means that that you should increase the ground balance value using the Up button. On the other hand, if you are getting a high tone, you should decrease the ground balance value using the Down button.

5. Continue the above process until the ground response is eliminated.

6. Press the Ground Balance button once to exit.

The ground balance value may vary in single frequencies and Multi frequency in certain soil types.

The sound may not be eliminated completely on certain terrains. In this case, if the ground noise is minimized, it means that the ground balance has been done.

Ground Tracking

The device tracks the changes in the ground during detection and updates the ground balance automatically. Ground changes that are not visible to the eye will affect the depth and discrimination performance of the detector.

1. To activate ground tracking, press the Ground Balance button once. The device will go into the ground balance screen.
2. Press the Pinpoint & Accept/Reject button once. In the Info Bar, next to the ground balance icon, ground tracking icon will appear.

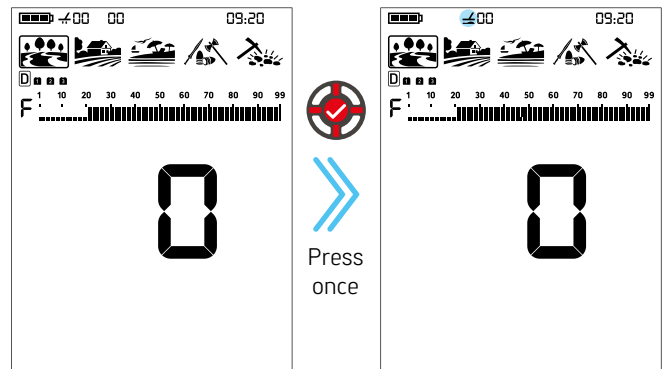

Ground tracking is now active. Press the Ground Balance button once to go back to the main screen.

When the Ground Tracking feature is activated, the ground balance icon and the numerical values indicating the ground balance level are removed from the information area. The Ground Tracking icon is displayed, and in the section showing real-time ground measurements, the ground balance level calculated by the Ground Tracking feature and at which the device is operating is shown.

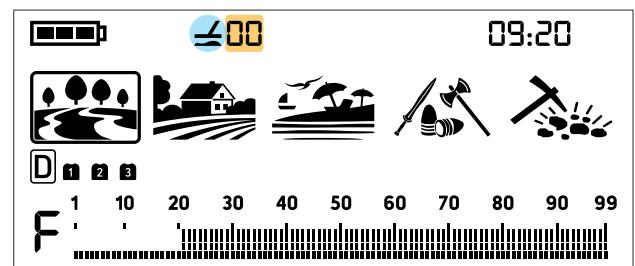

The device updates the ground balance automatically as long as the search coil is swung over the ground.

Tracking is suitable for use in areas where different soil structures are present within the same land or in fields where mineralized rocks are scattered widely apart. If you use ground tracking in areas where hot rocks are intensely present, the device may not be able to eliminate these highly mineralized rocks or you may miss the smaller or deeper metals.

When the Tracking feature is activated, the ground balance level flashes on the screen. In Relic mode, when the Ground Balance 2 is activated while the tracking feature is on, the ground balance level will be shown steady to avoid confusion.

Second Ground Balance Feature in Relic Mode

Due to its configuration, Relic mode may cause the device to give false signals to ground changes and mineralized/hot rocks. This may cause discomfort to the user during detection. Relic mode offers users a 2nd Ground Balance feature to overcome mineralized/hot rocks, red bricks and other ground changes in the surrounding environment that have different properties than the soil that's been ground balanced. With the second ground balance, depending on the properties of the hot rock or brick, in some cases, complete silence can be achieved over these falsing targets. In other cases, a broken signal may be heard. Broken sounds indicate that the detected target is a mineralized/hot rock.

To use this feature:

1. Press the Ground Balance button to access the setting.
2. Activate the 2nd Ground Balance feature by pressing the Quick Settings button. When the 2nd Ground Balance is activated, the number "2" appears on the screen above the letters Gb.

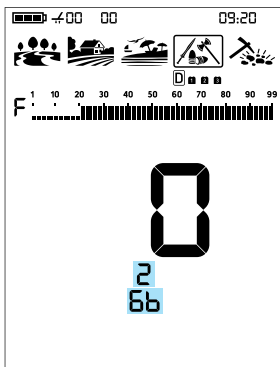

3. You can perform the 2nd Ground Balance by pressing and holding the Pinpoint & Accept/Reject button.

When Relic mode is selected, 1st and 2nd Ground Balancing can only be performed automatically. Manual ground balancing is not possible.

4. You can switch back from the 2nd Ground Balance to the 1st Ground Balance by pressing the Quick Settings button again.

Resetting the 1st and 2nd Ground Balance Settings in the Relic Mode

While Relic mode is selected, the Ground Balance value is reset by entering the ground balance menu and long pressing the Up button. When the button is held down, the animation is shown on the screen. To reset the 2nd Ground Balance value, first activate the 2nd Ground Balance. Reset the 2nd Ground Balance value by pressing the Up button again.

PINPOINT

PP Pinpoint is to find the center or the exact location of a detected target.

The LEGEND 2 is a motion detector. In other words, you are required to move the search coil over the target or the target over the search coil in order for the device to detect the target. The pinpoint mode is a non-motion mode. The device continues to give a signal when the search coil is kept stationary over the target.

When the Pinpoint & Accept/Reject button is pressed, unused icons are cleared from the screen. The pinpoint icon and the FerroCheck™ bars are displayed empty.

In Pinpoint mode, the device continues to provide Target ID and perform metal discrimination.

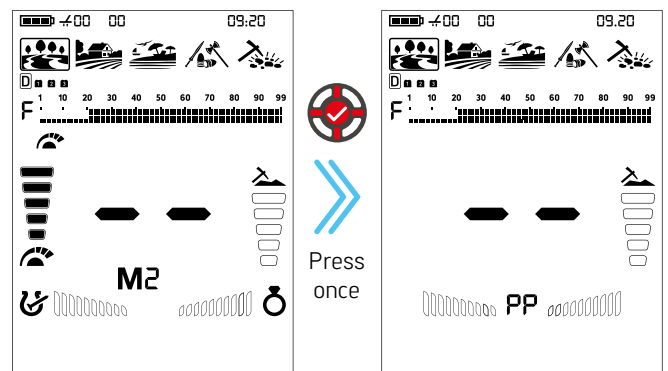

To perform pinpoint:

1. After a target is detected, move the search coil aside where there is no target response and push the Pinpoint & Accept/Reject button.
2. Bring the search coil closer to the target slowly and parallel to the ground.
3. Signal sound becomes stronger and changes in pitch while getting closer to the target center and the bars in the FerroCheck™ start filling up from the outside to the inside.
4. Mark the position which provides the loudest sound using a tool or your foot.
5. Repeat the above procedure by changing your direction 90°. Actions to be performed from a couple of different directions will narrow the target area and provide you with the most exact details of the target location.

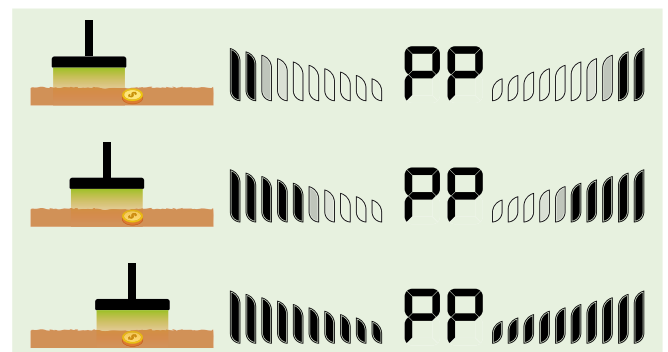

FERROCHECK™

 The Target ID sometimes is not sufficient. FerroCheck™ shows the ferrous/non-ferrous ratio of targets graphically on the screen.

The FerroCheck™ feature is a proprietary technology developed by Nokta and is also available on The LEGEND device. It graphically presents the Ferrous / Non-Ferrous ratio contained in the target signal, enabling users to perform more accurate target discrimination.



Targets such as large iron, rusted nails, bottle caps contain both ferrous and non-ferrous signals and these types of targets cannot be discriminated by Target ID and audio response only. These types of targets may generate a non-ferrous audio response as well as a Target ID.

IMPORTANT! Until you get experienced with this feature, it is recommended to dig out all targets. By comparing the targets with the FerroCheck™ graphs, users can use this feature more productively to identify targets.

Ferrous Target

Targets with ferrous signal only will be identified as 100% ferrous both in Target ID and FerroCheck™ as shown below:

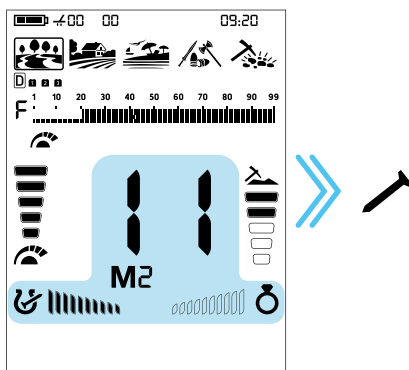

True Non-Ferrous Target

Targets with non-ferrous signal only will be identified as 100% non-ferrous both in Target ID and FerroCheck™ as shown below:

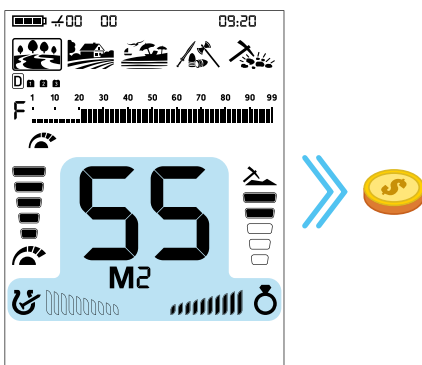

False Non-Ferrous Target

When targets such as bottle caps generate a non-ferrous Target ID, the FerroCheck™ feature identifies them as alloy with ferrous (iron) content, as shown below.

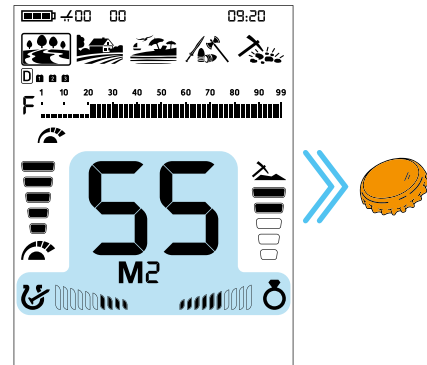

The target generates a non-ferrous ID. However, it has both ferrous and non-ferrous signal.

IMPORTANT! For the FerroCheck™ feature to work, the detector must receive a strong signal. Therefore, FerroCheck™ is designed to work with shallower targets.

Correct Usage of the FerroCheck™

The accuracy of the FerroCheck™ feature is directly related to correct usage. Therefore, once you detect a target, if you want to check whether the target is ferrous or non-ferrous with the FerroCheck™, please pay close attention to the instructions below:

1. You MUST sweep the coil with a large angle over the target and make wide scans. Make sure that the search coil leaves the signal completely during the sweeps.
2. You must go around the target and swing the coil over it from different angles, with long sweeps again.
3. The ferrous side does not need to fill up completely. More than 2 bars is enough to identify a target as an alloy containing iron (not a true non-ferrous target).

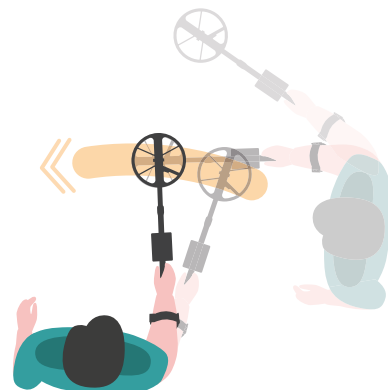
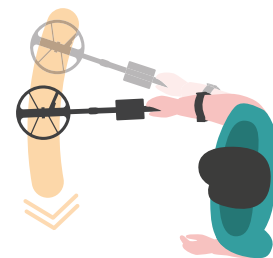

MINERALIZATION INDICATOR

Ground Mineralization refers to the naturally occurring minerals in the ground that affect a metal detector's performance. For metal detectors, ground mineralization is caused by iron particles present in the soil and by salt found in environments such as wet sand. These factors cause the ground to be either magnetic or conductive. Both produce false signals that mask targets.

Left side of the mineralization bar shows iron particle mineralization and the right side shows mineralization due to salt.

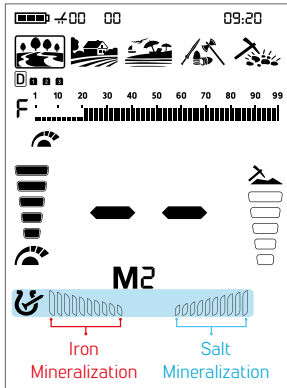

Salt mineralization operates only in Multi frequency; therefore, the mineralization indicator is updated according to the selected frequency.

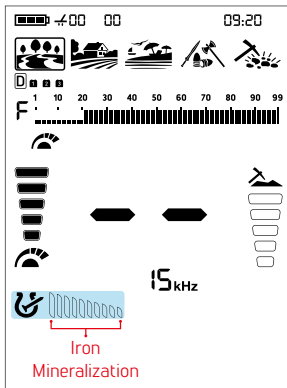

In single frequency, only the iron mineralization works. In Multi frequency, both the iron and salt mineralization indicators work.

The selection of whether FerroCheck™ or the Mineralization indicator will be displayed is explained in the FerroCheck™ / Mineralization Option section.

The Salt Mineralization Indicator has been introduced to users for the first time in the world by Nokta Engineering.

TARGET DEPTH

The device provides an estimated target depth according to the signal strength during detection.

Depth Indicator: It shows the target's proximity to the surface in 5 levels during detection. As the target gets closer, the levels decrease and vice versa.

Depth detection is adjusted presuming that the target is a 2.5 cm (1") coin. Actual depth varies according to the size of the target. For instance, the detector will indicate more depth for a target smaller than a 2.5 cm (1") coin and less depth for a larger target.

Shallow target



Deep target



IMPORTANT! As the operating frequency of the device has a direct impact on the device, the estimated depth may vary for the same target during frequency changes.

QUICK SETTINGS

To access the Quick Settings, press the Down button, Up button, or Quick Settings button once. When pressed, the quick settings located below the ID scale will appear, the icon of the selected setting will be highlighted with a frame, and its value will be displayed on the screen.

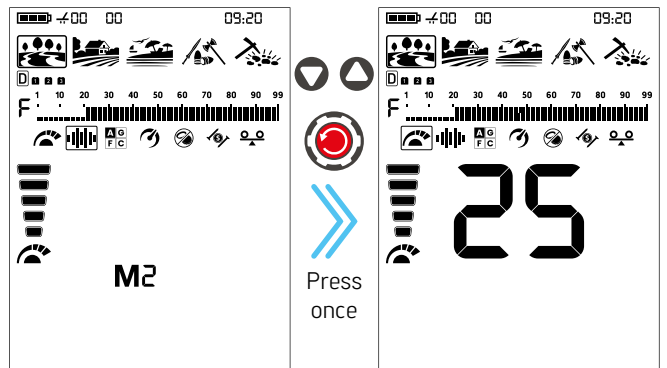

Navigation Through Settings

You can navigate through the quick settings using the Right and Left buttons. The selected quick setting will blink and be framed for easier visibility.

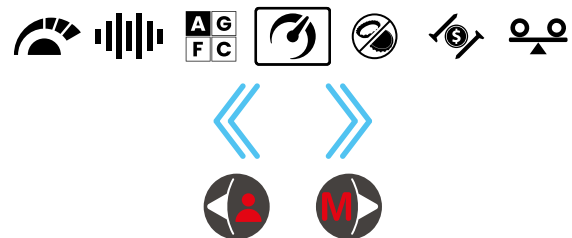

Changing the Value of the Selected Feature

You can change their values using the Up and Down buttons.



Exiting the Menu

To exit the quick settings, press the Quick Settings button once.

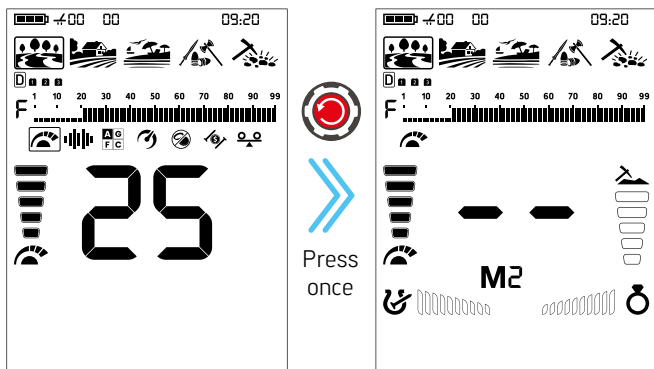

Changing the Selected Quick Setting on the Main Screen

After exiting the menu, the last selected quick setting remains on the main screen. When the Quick Settings menu is not open, you can change the value of the selected quick setting on the main screen using the Up and Down buttons. The changed quick setting will blink for easier visibility.

The Quick Settings menu has two different operating modes. By factory default, when you exit the Quick Settings menu, the last adjusted setting remains selected. If you want the selected setting to always be Sensitivity, regardless of which setting was adjusted last when exiting the Quick Settings menu, navigate to the Sensitivity setting and press and hold the Pinpoint & Accept/Reject button until the letters **SS** (Sensitivity Selected) appear in the extra display area. The operating mode of the Quick Settings menu is then updated so that it always selects the Sensitivity setting when exiting the menu. This change is stored in the device's memory and remains active even after the device is powered off and on again. If you want to revert the Quick Settings menu to the factory default behavior—where the last adjusted setting remains selected—navigate to the Sensitivity setting and press and hold the Pinpoint / Confirm button until the letters **LS** (Last Selected) appear in the extra display area.

The settings available in the Quick Settings menu are displayed based on the selected mode, frequency, and other settings.

When single frequencies are selected, only the first four Quick Settings options are displayed in the Quick Settings menu. Other features are not shown, as they are exclusive to Multi frequency.



When the Relic search mode is selected, only the first five quick settings are displayed in the quick settings menu. Since the Relic mode operates only in Multi frequency, the frequency selection option is skipped.



The other modes, except for the Relic search mode, have an iron filter setting in their Multi frequency options.

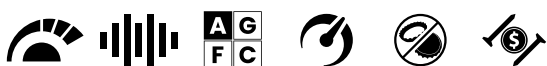

The Stability setting exists only in Beach mode.



If no button is pressed after changing a quick setting with the Up and Down buttons, the device will automatically exit the Quick Settings and return to the main screen.

1. Sensitivity

- Sensitivity is the depth setting of the device. It is also used to eliminate the ambient electromagnetic signals from the surrounding environment and noise signals transmitted from ground.
- Sensitivity consists of 30 levels and default setting is 25.

Sensitivity setting is a personal preference. However, It is important to set the sensitivity to the highest level possible where no major popping sounds are heard to avoid missing smaller and deeper targets. For example; if the noise level is suitable for searching and is the same at level 25 and 30, then 30 should be preferred.

Park Field Beach
P F B
Relic R G
Tool
 Sensitivity is a common setting for all modes and changes to this setting will affect them all.

Changing the Sensitivity

Open the Quick Settings. Use the Right and Left buttons to select the Sensitivity feature.



The current Sensitivity value will be displayed on the screen.

You can increase or decrease it using the Up and Down buttons. Each press adjusts the sensitivity step by step, while holding the buttons changes it rapidly.

You can exit the menu by pressing the Quick Settings button.

The Sensitivity Indicator is located on the left side of the Target ID. The indicator consists of 5 levels. Each level represents 6 units of sensitivity.

The sensitivity values corresponding to each level on the Depth Indicator are shown below:

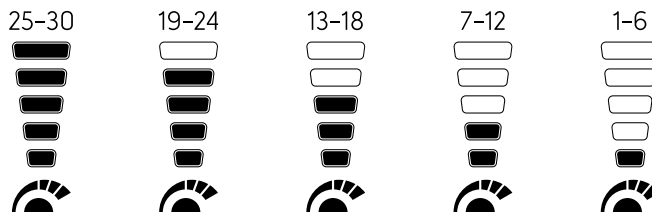

The device always starts with the last adjusted sensitivity level.

IMPORTANT! To obtain maximum depth performance, to eliminate the noise caused by electromagnetic interference, try shifting the frequency first.

2. Frequency

The LEGEND 2 offers Multi frequency, where a wide range of frequencies work simultaneously, as well as 5 single frequencies.

Changing the Frequency

Open the Quick Settings. Use the Right and Left buttons to select the Frequency feature.



You can easily switch between frequencies at any time using the Up and Down buttons.

You can exit the menu by pressing the Quick Settings button.

It is recommended to use Multi frequency in all modes. When Multi frequency is selected the letter "M" appears on the screen. When a single frequency is selected, the frequency is shown numerically on the screen.

The table shows the frequencies available in the search modes.

Frequency Operation By Mode

	PARK	FIELD	BEACH	RELIC	GOLD
Multi	✓	✓	✓	✓	✓
4 kHz	✓	✓	✗	✗	✗
10 kHz	✓	✓	✗	✗	✗
15 kHz	✓	✓	✗	✗	✗
20 kHz	✓	✓	✗	✗	✓
40 kHz	✓	✓	✗	✗	✓



Frequency only affects the mode currently selected; changes made in one mode do not affect the others.

Single Frequencies

Sometimes using single frequencies may provide an advantage over Multi frequency. For example; if you are looking for larger high conductive targets only, the 4 kHz may be a better choice. Similarly, if you are looking for shallow, thin jewelry, 20 kHz and 40 kHz may provide better results.

In areas where there is electromagnetic interference, single frequencies may be less noisy compared to Multi frequency. However, they will be less sensitive to many targets at the same time.

4 kHz will provide more depth specifically for larger silver coins and relics compared to Multi and other frequencies but it will be noisy in certain soil conditions.

Multi Frequency

Multi frequency which runs multiple frequencies simultaneously gives the user the advantage of covering a broader range of targets on all types of terrains.

Multi frequency, compared to single frequencies, typically provides more accurate IDs at depth. In addition, it offers maximum depth for a large range of metals with different sizes on wet salt beach sand and underwater by minimizing ground noise.

Modes and Frequencies

Each search mode has been optimized with frequencies to offer the best performance. For example, Park and Field mode works in all single frequencies as well as Multi. On the other hand, the Beach mode will only perform well in Multi frequency so single frequencies cannot be selected in this mode. In addition, in the Beach mode the Multi frequency has 2 options: Multi Wet (MW) and Multi Dry (MD).

^wM _dM

The Gold mode, on the other hand, is optimized to detect smaller low conductive targets and that is why the lower single frequencies (4 kHz, 10 kHz and 15 kHz) cannot be used in this mode.

Unlike other modes, Park and Field mode offers three Multi frequency options: Multi-1 (M1), Multi-2 (M2) and Multi-3 (M3). M1 is more sensitive to high conductors, while M2 provides better detection of low conductors.

Multi-3 Frequency is ideal for damp, wet, and/or conductive soils. It reduces the effect of moisture that can cause false signals in the ground. It also weakens the responses of targets such as coke and aluminum foil, which give a Target ID of 20-21.

M1 M2 M3

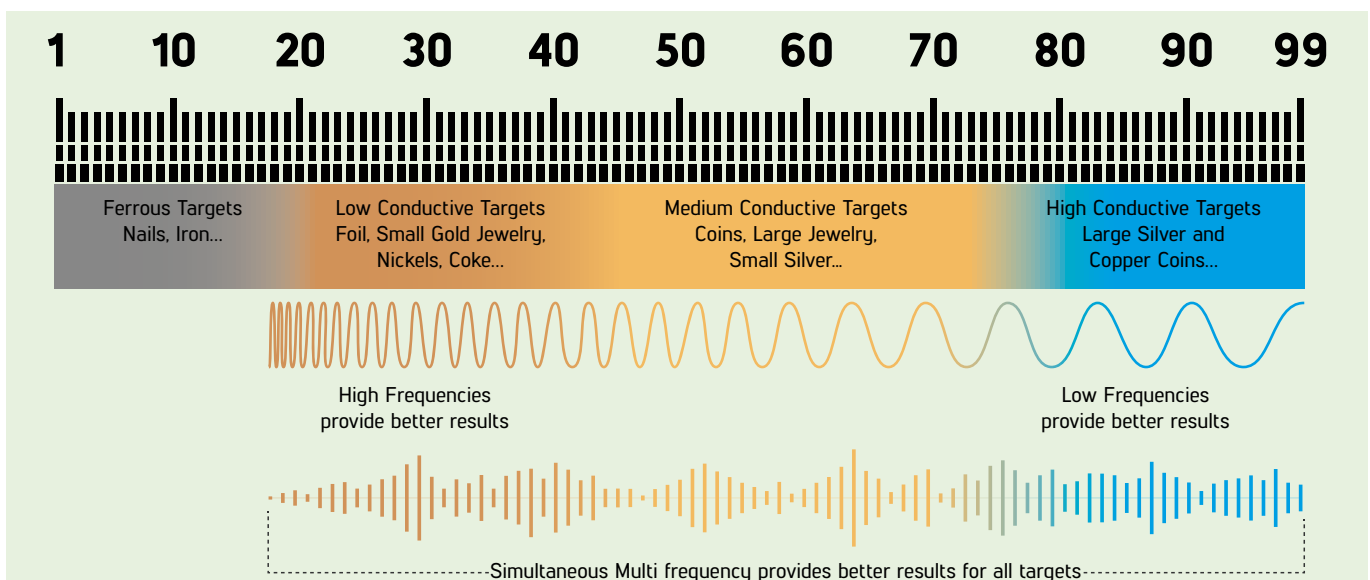

3. Discrimination Patterns



The LEGEND 2 offers advanced discrimination setting to users for an easier operation. By Using the Discrimination Mode feature, you can select one of 3 preset discrimination models or 1 fully user-controlled model. In the Custom discrimination pattern, each ID can be rejected or accepted by the user.

The default discrimination pattern for Park, Field, and Beach modes is "F" discrimination pattern which stands for (Ferrous Off). In Gold mode, the default discrimination pattern is "G" (Ground Off). In Relic mode, the default discrimination model is "A", which is the (All Metals) discrimination model.

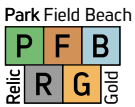

The discrimination setting only affects the mode currently selected; changes made in one mode do not affect the others.



All Metal Discrimination Pattern

In this pattern all ID's are accepted on the ID scale (1-99). In other words, all the lines on the scale are visible and no ID is rejected. The device will emit an audio response for all metals as well as the ground and their IDs will be displayed on the screen.



Ground Off Discrimination Pattern

In this pattern, the device will not receive ground noise and will not provide any audio or Target ID for it. Target IDs 1-4 are turned off (rejected) and the rest are open (accepted).



Ferrous Off Discrimination Pattern

In this pattern, the device will not provide any audio or Target ID for ferrous targets. Target IDs 1 - 20 are turned off (rejected) and the rest are open (accepted).



Custom Discrimination Pattern

This pattern allows users to create their own discrimination pattern according to the type of targets they would like to accept and reject. Rejected IDs will vary based on the search mode.

Accepting and rejecting IDs are also referred to as "notching" or to "notch".

The default, accepted and rejected IDs in the Custom Discrimination Pattern for each mode are shown in the table below:

Rejected And Accepted IDs In Modes' Predefined Custom Discrimination Patterns

Search Mode	Rejected IDs	Accepted IDs
PARK	1-21	22-99
FIELD	1-21	22-99
BEACH	1-20	21-99
RELIC	1-20	21-99
GOLD	1-20	21-99

Default Discrimination Patterns by Mode

Search Mode	Discrimination Patterns
PARK	Ferrous Off (F)
FIELD	Ferrous Off (F)
BEACH	Ferrous Off (F)
RELIC	All Metal (A)
GOLD	Ground Off (G)

Changing the Discrimination Pattern

Open the Quick Settings. Use the Right and Left buttons to select the Discrimination Mode feature.



You can easily switch between Discrimination Modes at any time using the Up and Down buttons.

Each time you change the discrimination pattern, the selected pattern is shown with a letter and a frame in the box on the left side of the ID scale.

You can exit the menu by pressing the Quick Settings button.

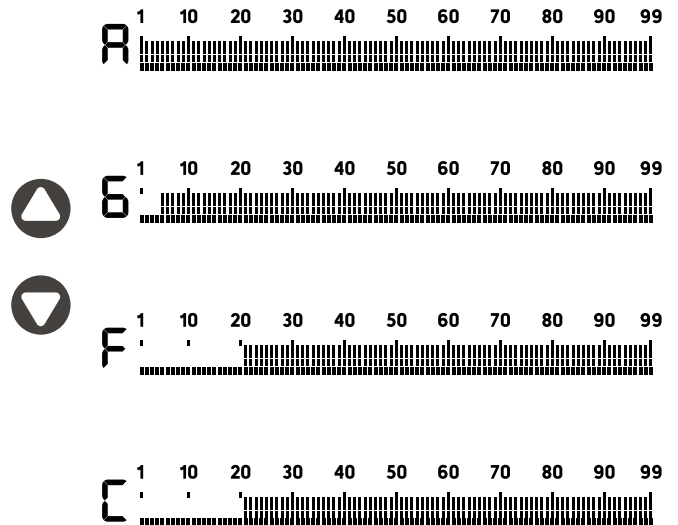

With the notch feature, you can accept (turn on) and reject (turn off) multiple IDs. The lines for the rejected IDs will be erased and these IDs will be blanked out on the ID scale. The device will not provide an audio response or Target IDs for these targets. The use of the ID Accepting / Rejecting feature is explained in the ID Accepting / Rejecting section.

4. Recovery Speed



The Recovery Speed setting adjusts the speed of target response.

It allows for separation between multiple targets in close proximity.

Recovery Speed setting enables you to detect smaller targets among trash or ferrous targets.

The LEGEND 2 Recovery Speed setting can be adjusted between 1 and 10 with 1 being the slowest and 10 being the fastest.



Recovery Speed setting only affects the mode currently selected; changes made in one mode do not affect the others.

When the Recovery Speed setting is set to a low number, the ability of the device to detect targets in close proximity decreases but its depth increases.

Similarly, a high Recovery Speed setting (for example 10) will increase the ability of the device to detect targets in close proximity but will decrease the depth.

It is recommended that you practice with different metals placed close to each other before starting to use this setting.

Adjusting the Recovery Speed

1. Open the Quick Settings. Use the Right and Left buttons to select the Recovery Speed feature. The current value will be displayed on screen.



2. Change the value of the Recovery Speed using the Up and Down buttons.

3. Press the Quick Settings button once to go back to the main screen.

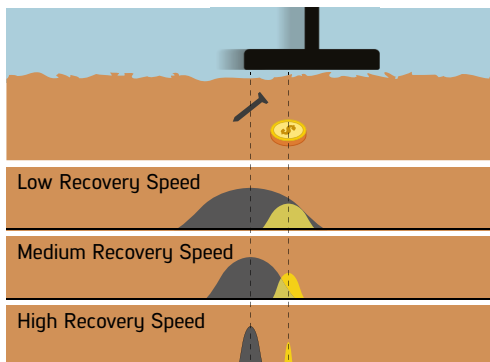

IMPORTANT! Increasing the Recovery Speed allows for a faster sweep rate with less chance of missing targets. Increasing Recovery Speed at the same sweep rate will help to eliminate ground noise but it will decrease detection depth.

Default Recovery Speed Levels by Mode

Search Mode	Recovery Speed
PARK	5
FIELD	5
BEACH	6
RELIC	5
GOLD	5

5. Bottle Cap Rejection



Bottle caps are unwanted targets for detectorists and they are mostly detected as non-ferrous targets by metal detectors. With the Bottle Cap Rejection setting, you can discriminate bottle caps as iron.

Bottle Cap Rejection setting can be set between 0 and 8 and the default setting is 0. This setting work in Multi frequency only.

Adjusting the Bottle Cap Rejection

Open the Quick Settings. Use the Right and Left buttons to select the Bottle Cap Rejection feature. The current Bottle Cap Rejection value will be displayed on the screen.



You can change the Bottle Cap Rejection setting value between 1 and 8 using the Up and Down buttons. When set to 0, this feature is off.

You can exit the menu by pressing the Quick Settings button.

5.1. Iron Rejection Feature in Relic Mode



Relic mode, like the Gold mode, produces signals for both non-ferrous and ferrous targets by changing the frequency of the sound according to the strength of the received signal. In order to distinguish ferrous targets, especially those closer to the surface, depending on the signal strength received from the ferrous target, the device emits a lower tone than that of the non-ferrous targets with the frequency varying according to the strength of the signal.

You can adjust the Iron Rejection value between 0 and 5. The default value is 0.

When the value is increased, the probability of emitting a ferrous tone for deep non-ferrous targets increases.

Adjusting the Iron Rejection

In Relic mode, open the Quick Settings. Use the Right and Left buttons to select the Bottle Cap/Iron Rejection feature. The current Iron Rejection value will be displayed on the screen.



You can change the Iron Rejection setting value between 1 and 5 using the Up and Down buttons. When set to 0, this feature is off.

You can exit the menu by pressing the Quick Settings button.

6. Iron Filter

 Iron filter allows desired non-ferrous targets in trashy sites, previously masked by iron, to be detectable.

The Iron Filter setting operates only in Multi frequency and can be adjusted between levels 1 and 9.

This setting is not available in Relic mode.

Level 9 will become handy when trying to discriminate some unwanted mid-conductors such as shotgun cartridges as iron.

Lower Iron Filter setting will increase the probability of ferrous targets to be classified as non-ferrous targets and vice versa.

Adjusting the Iron Filter

When the device is operating in Multi frequency mode, open the Quick Settings. Use the Right and Left buttons to select the Iron Filter feature. The current Iron Filter value will be displayed on the screen.



You can change the Iron Filter setting value using the Up and Down buttons.

You can exit the menu by pressing the Quick Settings button.

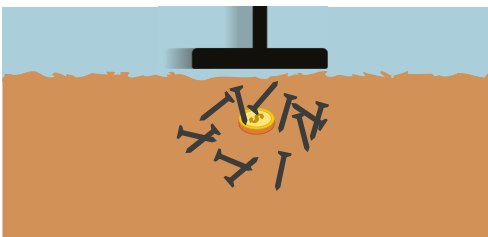

Default Iron Filter Levels By Mode

Search Mode	Iron Filter
PARK	3
FIELD	3
BEACH	1
RELIC	-
GOLD	3

7. Stability in Beach Mode

 With this setting, you can minimize the ground noise and false signals on the beach for a more comfortable metal detecting experience.

The stability can be set between 1 and 5. The default setting is 5. Level 5 will offer maximum stability. As the stability is increased though, the signal of lower conductors such as gold with 21 ID may diminish and the chances of missing these metals will increase. This setting has no effect on mid to high conductors.

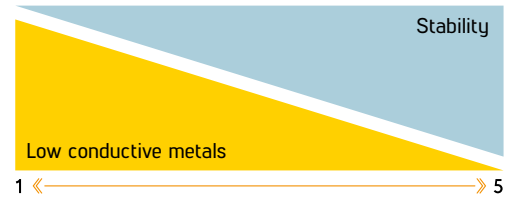

Adjusting the Stability in Beach Mode

In Beach Mode, open the Quick Settings. Use the Right and Left buttons to select the Stability feature. The current Stability value will be displayed on the screen.



Use the Up and Down buttons to change the Stability setting value.

Press the Quick Settings button to exit the menu.

IMPORTANT! In some environments, 4th level of the stability setting may provide better stability than level 5. This is related to the salinity of the water.

SETTINGS

To go into the settings menu, press the Power / Settings button once. Once the button is pressed all the settings will be displayed at the bottom of the screen. The selected setting will be shown framed and its value will be displayed on screen.

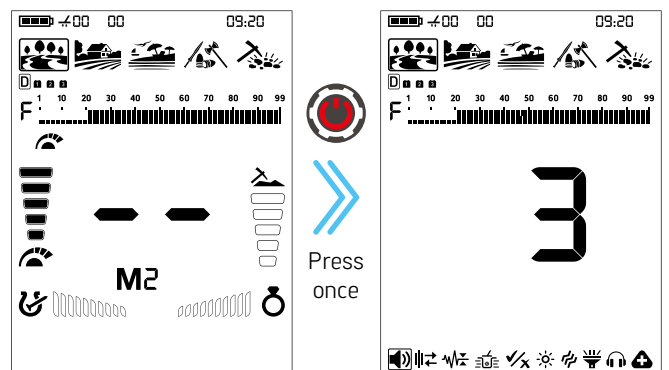

Navigation Through Settings

You can navigate through the settings using the Right and Left buttons. The selected setting will blink for easier viewing.

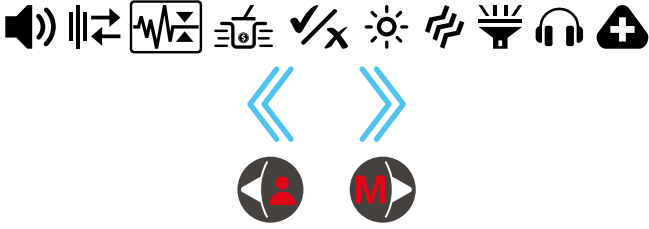

Adjusting a Setting

You can adjust the value of a setting using the Up and Down buttons.



Exiting the Settings Menu

Press the Power / Settings button once to exit the settings menu.

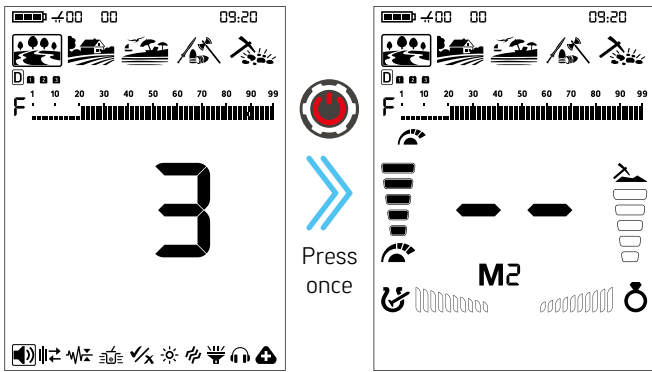

1. Volume Level

This setting allows you to adjust the device's overall volume level.

Volume level setting consists of 10 levels and it is set to 7 by default. When you turn off and on the device, it will start with the last volume level you chose.

Park Field Beach



This setting is common to all modes; changes will take effect in all modes.

Adjusting the Volume

1. Press the Power / Settings button once. Select Volume using the Right and Left buttons. The current value will be displayed on screen.



2. Change the volume level using the Up and Down buttons.

3. Press the Power / Settings button once to go back to the main screen.

Because the volume level affects power consumption, we recommend you not to increase it more than necessary.

IMPORTANT! When you change the volume of the device with this setting, the volume of the metal zones adjusted by the Tone Volume setting will also change proportionally.

2. Frequency Shift

It is used to eliminate the electromagnetic interference that the device receives from another detector which operates in the same frequency range nearby or from the surroundings (high voltage power lines, cellular base stations, wireless radios and other electromagnetic devices).

There are 19 channels available for all frequencies including Multi frequency. The default channel is 10.

Park Field Beach Frequency Shift only affects the mode and frequency currently selected; changes made in one mode does not affect the other modes or frequencies.
Relic R Gold G

If too much noise is received when the search coil is lifted in the air, this may be caused by the local electromagnetic signals or high sensitivity level.

To achieve maximum depth performance and reduce noise caused by electromagnetic interference, try shifting the frequency before lowering the sensitivity.

Detectors may become noisy due to electrical interference and may exhibit erratic behavior such as loss of depth or unstable Target ID. The Frequency Shift setting allows you to slightly shift the detector transmit frequency to eliminate unwanted noise.

Frequency Shift can be done in 2 ways in The LEGEND 2: Manual and Automatic.

In the manual Frequency Shift, the operator listens to each channel and selects the one with the least noise.

In the automatic one, the device scans all the channels and picks the least noisy one itself. This feature is often referred to as Noise Cancellation as well.

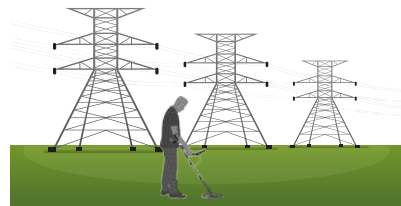

Shifting the Frequency

1. Hold the coil stationary and away from the ground.



2. Press the Power / Settings button once. Select the Frequency Shift setting using the Right and Left buttons. The current channel will be displayed on screen.

Manual Use

1. Using the Up and Down buttons, go through the frequency channels.
2. Select the one you think is the one with the least interference.

Automatic Use

1. Before doing a noise cancellation, lift the device up in the air as shown in the picture and hold it still until the process is completed.

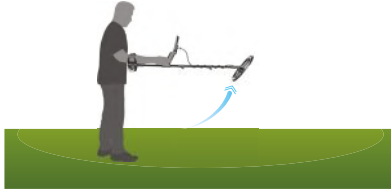

2. Press the Pinpoint & Accept/Reject button once.
3. The device will start scanning all channels, and a scanning animation will be displayed on the screen during the scan.
4. When the process is complete, the automatically selected channel number is displayed and a confirmation tone is heard.

Press the Power / Settings button once to go back to the main screen.

IMPORTANT! Automatic Frequency Shift selects the quietest channel based on various criteria. In some cases, the selected channel may still produce some noise.

3. Ground Suppressor

 This setting is used to eliminate false ground signals in challenging terrains. It can be used with both Multi and Single frequencies. It is recommended to keep this setting in the off position unless needed.

You can adjust the Ground Suppressor value between 0 and 8. The default value is 0.

Adjusting the Ground Suppressor

1. Press the Power / Settings button once. Use the Right and Left buttons to select the Ground Effect Eliminator setting. The current Ground Effect Eliminator value will be displayed on the screen.



2. Use the Up and Down buttons to adjust the Ground Effect Eliminator setting between 1 and 8. When set to 0, this feature is disabled.

4. Deep Target Identification

 This feature allows non-ferrous deep targets, which are masked or detected as iron (ferrous), to be detected as non-ferrous.

You can adjust the Deep Target Identification value between 1 and 3. The default value is 3.

This feature can be used in all modes except the Relic mode with both Multi frequency and Single frequencies.

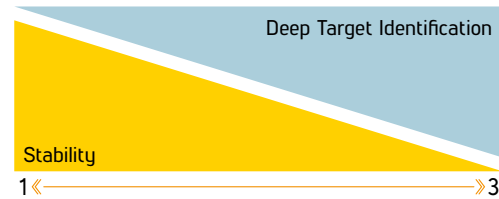

Adjusting the Deep Target Identification

Press the Power / Settings button once. Use the Right and Left buttons to select the Deep Target Identification setting. The current Deep Target Identification value will be displayed on the screen.



Use the Up and Down buttons to adjust the Deep Target Identification setting between 1 and 3.

5. Notch (Accepting and Rejecting IDs)



On The LEGEND 2 device, IDs range from 1 to 99, and each ID is represented by a single bar on the ID scale. This provides users with precise control over each individual ID. With the Accepting / Rejecting IDs (Notch) feature, users can accept or reject any desired ID.

Forming a Customized Discrimination Pattern

Press the Power / Settings button once. Use the Right and Left buttons to select the Notch (Accepting and Rejecting IDs).

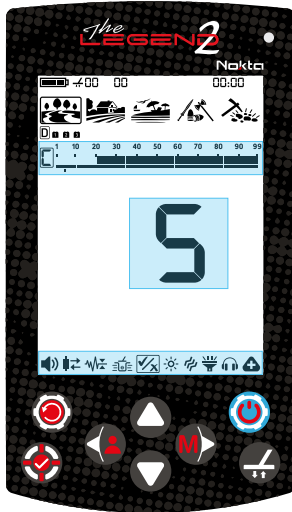

Regardless of which discrimination pattern is selected, when the Accepting / Rejecting IDs (Notch) feature is selected, the device automatically switches to the Custom Discrimination Pattern (C), and the selected Discrimination Pattern displayed next to the ID scale is highlighted with a frame.

There are two options to create a Custom Discrimination Pattern: Manual and Automatic.

Manual Notch:

Hold the coil stationary. The last Target ID number left on the screen will be displayed, and an arrow-shaped cursor will appear under the Target ID scale. In manual mode, Target ID selection can be made one by one and sequentially.

Single Target ID Selection:

1. Move the cursor using the Up and Down buttons. Each time you press a button, the Target ID numbers on the screen will change. Select the ID you want to enable or disable.

2. Press the Pinpoint & Accept/Reject button. If the selected ID is disabled, it will be enabled; if it is enabled, it will be disabled. You can track the changes on the Target ID scale.

Sequential Target ID Selection:

1. Press the Quick Settings button. This activates consecutive Target ID selection. Using the Up and Down buttons, move the cursor at the bottom. Target IDs that are off are turned on, and selected Target IDs are turned off.

When the setting is activated, the letters "Co" are displayed on the screen.

Co: Sequential

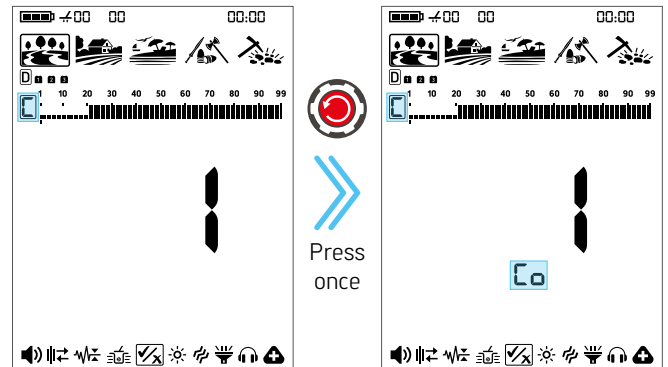

2. After you make the desired adjustment, pressing the Quick Settings button will disable consecutive Target ID selection.

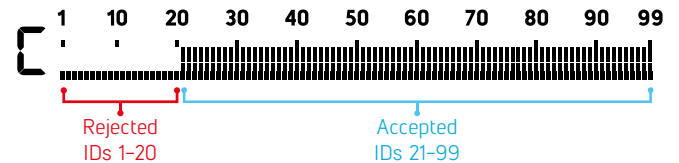

Automatic Notching:

1. In the Notch (Accepting and Rejecting IDs) setting, sweep the search coil over the metal whose ID you want to turn off. The cursor below the Target ID scale and the Target ID value indicate the ID number you want to disable or enable.

2. Sweep the search coil to obtain the Target ID value, then press the Pinpoint & Accept/Reject button to enable it if it is disabled, or disable it if it is enabled.

Automatic Sensitivity Reduction

During automatic operation, if ID values fluctuate too much, press the "Ground Balance" button to temporarily lower the Sensitivity level. This allows the ID Enable/Disable process to be performed more easily.

In the ID Enable / Disable setting, pressing the "Ground Balance" button automatically lowers the Sensitivity level. The letters "LS" are displayed on the screen.

LS: Low Sensitivity

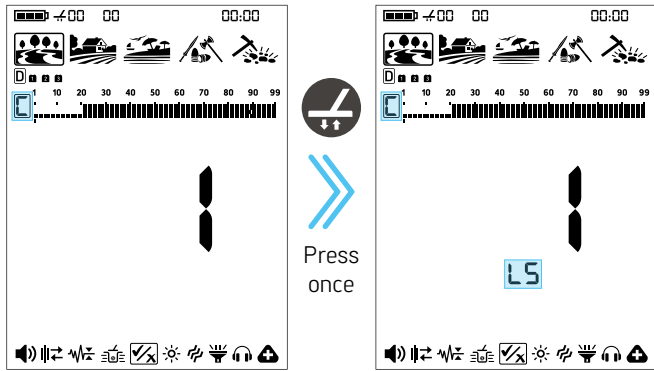

When both the "Automatic Sensitivity Reduction" and "Sequential ID Enable / Disable" features are activated, the screen appears as shown below:

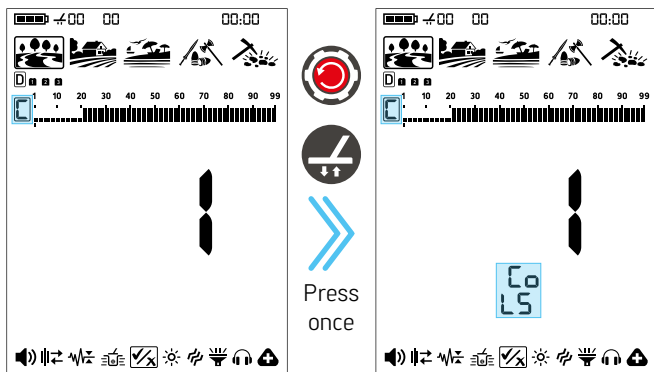

The LEGEND 2 does not produce a sound for rejected targets, but it displays their ID values on the screen in the Notch (Accepting and Rejecting IDs) setting.

When you re-enter the Notch (Accepting and Rejecting IDs) setting, the cursor and Target ID remain in their last position.

You can press the Power / Settings button to exit the menu.

IMPORTANT! When you exit the Notch (Accepting and Rejecting IDs) setting, the currently selected Discrimination Pattern remains active. If you want to switch to the "C" Custom Discrimination Pattern, you can change the Discrimination Pattern from the quick settings.

6. Screen and Keypad Backlight

It enables you to adjust the display backlight level according to your personal preference.

It ranges from 0 to 5 and A1 to A5. At 0 level, the backlight is off. At 1-5 levels, it will be continuously lit. At A1-A5 levels, it lights up only for a short period of time when a target is detected or while navigating the menu and then it goes off.

Park Field Beach

P	F	B
Relic	R	G
		Dial

 This setting is common to all modes; changes will take effect in all modes.

Adjusting the Keypad Backlight

When the Screen Backlight setting is selected, you can turn the keypad backlight on or off by pressing the Pinpoint & Accept/Reject button.

The continuous operation of the backlight will affect power consumption, which is not recommended. The backlight setting is restored to the final saved setting when the device is turned off and on again.

Adjusting the Backlight

1. Press the Power / Settings button once, and use the Right and Left buttons to select the Screen Backlight setting.



2. Change the backlight level using the Up and Down buttons.

3. Press the Power / Settings button once to go back to the main screen.

When the backlight is on, the backlight icon will be displayed in the Info Bar at the top of the screen.



7. Vibration



This feature provides feedback to the user by producing a vibration effect when a target is detected.

It can be used independently or together with the audio response. When audio response is disabled, all responses during target detection are provided to the user as vibration only.

The Vibration setting can be set to 0 (Off) or 1 (On). At 0 vibration is off. The magnitude of the vibration effect can vary according to the depth of the target and the swinging speed.

Park Field Beach

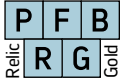

This setting is common to all modes; changes will take effect in all modes.

When you turn off and on the device, it will start with the last vibration level you chose.

Adjusting the Vibration

1. Press the Power / Settings button once. Select vibration using the Right and Left buttons. The current value will be displayed on screen.



2. Change the level using the Up and Down buttons.

3. Press the Power / Settings button once to go back to the main screen.

When the vibration is on, the vibration icon will be displayed in the Info Bar at the top of the screen.



Even if the vibration is on, it will not generate a response for targets while in the settings menu but only in the detection screen.

8. LED Flashlight



Use this setting to operate a headlight that illuminates the search area during night or low-light conditions.

LED Flashlight does not operate when the device is off. It is recommended to turn it on only when necessary since its operation consumes extra battery power.

LED Flashlight setting can be set to 0 (off) or 1 (on). The LED Flashlight will be off at each start up.

Turning the LED Flashlight On/Off

1. Press the Power / Settings button once. Select LED Flashlight using the Right and Left buttons. The current value will be displayed on screen: 0 (Off) or 1 (On).



2. Turn the flashlight On/Off using the Up and Down buttons.

3. Press the Power / Settings button once to go back to the main screen.

When the LED Flashlight is on, the flashlight icon will be displayed in the Info Bar at the top of the screen.



AUDIO OPTIONS



This setting is used to select the audio output.

To select the audio output, choose the Audio Options setting from the Settings menu. When this setting is selected, three different audio output options are displayed on the screen. You can change the audio output option using the Up and Down buttons. The default audio output is the speaker.

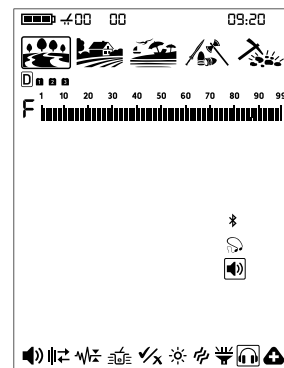

1. Speaker



When the speaker icon in the sound options settings is selected, the sound is emitted through the device's speaker.

2. Bone Conduction Headphones



When the bone conduction headphones icon in the sound options settings is selected, the sound is emitted through the bone conduction headphones.

IMPORTANT! When the bone conduction headphone audio output is selected, make sure that the bone conduction headphones are connected. If the bone conduction headphones are not connected, you will not receive any audio output from the detector.

3. Bluetooth® Headphones



When the Bluetooth® icon in the sound options settings is selected, The LEGEND 2 turns on Bluetooth® and enters pairing mode. In pairing mode, the Bluetooth® icon blinks.

The device will search for the headphones it has been paired with initially and try to connect to those. This will prevent the device from connecting to other Bluetooth® devices when the Bluetooth® setting is on. If you want to pair the device with different Bluetooth® headphones (other than those it was initially paired with) you must delete them from memory.

Once it pairs with any Bluetooth® headphones (Nokta BT Headphones or others), one of the icons below will be displayed in the Info Bar:

When headphones are connected, they will automatically turn off if no sound is transmitted from the device for 14 minutes.

Standard Bluetooth® headphones connected.

aptX™ Low Latency headphones connected.

When pairing with Bluetooth® headphones is established, if one of the icons above is selected, the sound is transmitted only through the Bluetooth® headphones.

For more detailed info about the Nokta BT Headphones, please read the instructions included with the headphones.

Deleting Paired Headphones From Memory

While in Bluetooth® setting, if the Pinpoint & Accept/Reject button is pressed long, the letters "Fd" will be displayed on screen for 2 seconds and the list of headphones that were paired with the device before will be deleted. If you want to pair a new pair of headphones after this, you must follow the pairing instructions again.

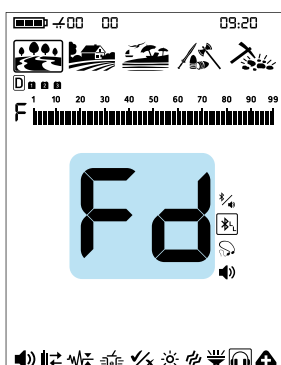

4. Multiple Audio Output



When the Bluetooth® icon is selected in the Audio Options settings and a Bluetooth® headphone connection is established, the option to output audio through both the Bluetooth® headphones and the device's speaker becomes active. In this mode, audio is transmitted simultaneously through the Bluetooth® headphones and the device's speaker.

5. Wired Headphones

Using the optionally available headphone adapter cable, you can connect and use wired headphones with your device. When wired headphones are connected to the device, a headphone icon will appear on the display.

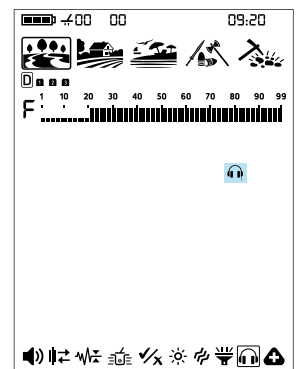
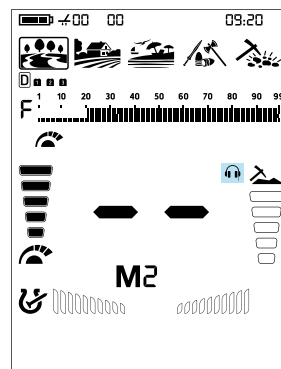

When a wired headphones are connected, it is detected automatically, and the audio option cannot be changed manually. To switch to another audio option, disconnect your wired headphones.

EXTRA SETTINGS

The Extra Settings menu contains nine different settings. Seven of these are related to audio. The Clock setting and the FerroCheck™ / Mineralization Indicator option are also located in this menu. When this setting is selected, the settings included in the Extra Settings menu are displayed on the screen.



Press the Up button once to enter the Extra Settings menu. Press the Quick Settings button once to exit the Extra Settings menu.

In the Extra Settings menu, all features are displayed in Park, Field, and Beach modes. However, the options available in Relic and Gold modes are different.

Extra Settings Menu in Relic Mode:



Extra Settings Menu in Gold Mode:

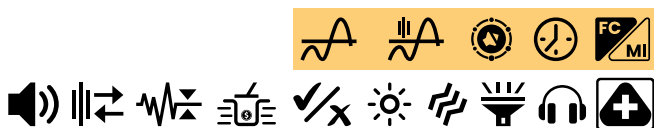

1. Number of Tones

The LEGEND 2 divides the Target ID scale into multiple zones allowing the user to make different tone adjustments for targets that fall in each zone.

By changing the Number of Tones, you can decide on how many zones you will divide the ID scale into. Thanks to this feature, you can assign the same tone for all targets or assign a different tone for each Target ID.

You can set the Number of Tones as 1, 2, 3, 4, 6, 99 or P (Tone Pitch).

Park	Field	Beach
Relic	R	Gold

The Number of Tones setting only affects the mode currently selected; changes made in one mode do not affect the others.

The Number of Tones for the Gold and Relic modes is 1 and cannot be changed.

Adjusting the Number of Tones

1. Press the Power / Settings button once. Select the extra settings using the Right and Left buttons.

2. Press the Up button once to access the extra settings.

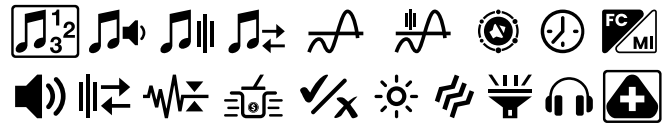

3. Using the Right and Left buttons, select the Number of Tones setting. The selected setting will be shown framed.

4. The current Number of Tones will be displayed on the screen. Select the Number of Tones using the Up and Down buttons.

5. To go back to the main screen, press the Power / Settings button once.

1-Tone

The Target ID scale is not divided into any zones, hence there is only 1-Tone zone. The LEGEND 2 generates the same tone volume and tone frequency for all targets.

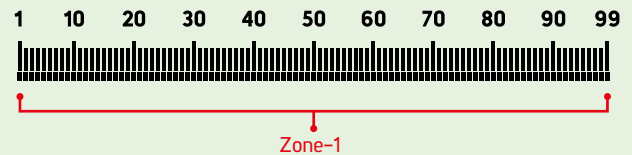

2-Tone

The Target ID scale is divided into 2 zones as ferrous and non-ferrous. The default point that separates these 2 zones vary based on the selected search mode (see below) and can be changed using the Tone Break setting. The Tone Volume and Tone Frequency can be adjusted for each zone.

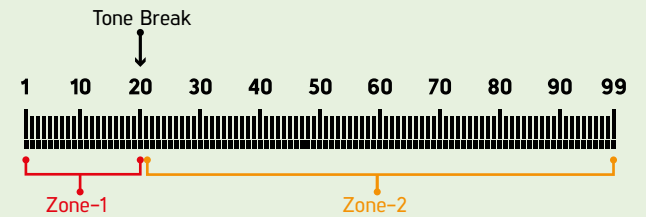

3-Tone

The Target ID scale is divided into 3 zones. The Tone Volume and Tone Frequency can be adjusted for each zone.

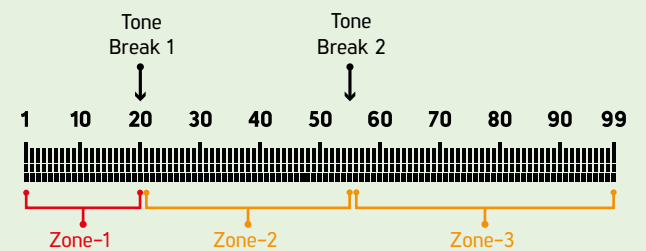

4-Tone

The Target ID scale is divided into 4 zones. The Tone Volume and Tone Frequency can be adjusted for each zone.

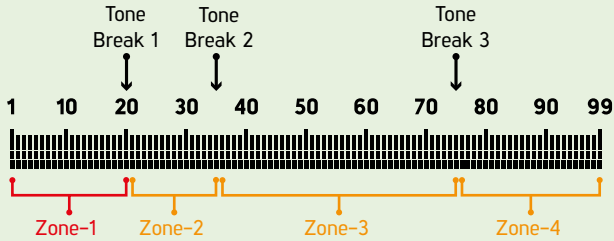

6-Tone

The Target ID scale is divided into 6 zones. The Tone Volume and Tone Frequency can be adjusted for each zone.

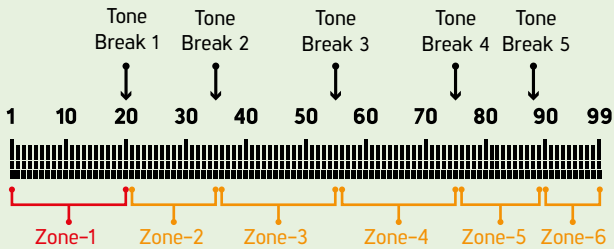

99-Tone

Just like the 2-Tone, the Target ID scale is divided into 2 zones as ferrous and non-ferrous. The default point that separates these 2 zones varies based on the selected search mode (see below) and can be changed using the Tone Break setting.

The Tone Volume and Tone Frequency can be adjusted for each zone.

The difference between the 2-Tone and 99-Tone is that 99-Tone generates a separate tone with a different frequency for each Target ID.

The device generates lower frequency tones for ferrous range and mid to high frequency tones for non-ferrous metals.

For more information, please refer to Tone Frequency setting.

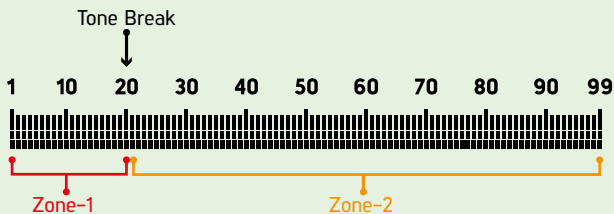

Tone Pitch

Just like the 2-Tone, the Target ID scale is divided into 2 zones as ferrous and non-ferrous. The default point that separates these 2 zones varies based on the selected search mode (see below) and can be changed using the Tone Break setting.

The Tone Volume and Tone Frequency can be adjusted for each zone.

In Tone Pitch, as the coil approaches the target, the audio frequency will change in proportion to the signal strength.

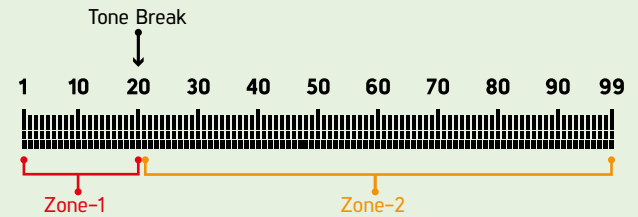

Default Number of Tones

Search Mode	Number of Tones
PARK	2
FIELD	2
BEACH	2
RELIC	1
GOLD	1

2. Tone Volume

 This setting allows you to adjust the volume level for each tone zone.

On trashy sites especially, detection is easier by turning off or lowering the volume of unwanted target audio responses.

The Tone Volume can be adjusted for each target zone. For example; in 1-Tone you can adjust the volume for 1 zone but in 6-Tone, you can adjust the volume of each zone separately.

Tone Volume setting range is from 0 to 10.

Park Field Beach
 Tone Volume Level setting is specific to the selected mode and the selected Target Tone Number, and any changes made affect only the Target Tone Number selected in that mode.

Tone Volume setting does not work in the Gold and Relic modes.

Adjusting the Tone Volume

1. Press the Power / Settings button once. Select the extra settings using the Right and Left buttons.
2. The extra settings top menu will appear on the screen. Press the Up button once.
3. Using the Right and Left buttons, select the Tone Volume setting. The selected setting will be shown framed.

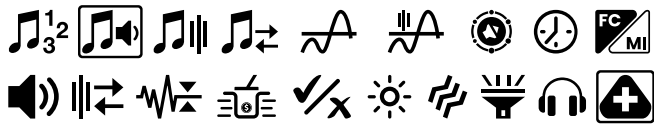

4. Press the Up button to go into the Tone Volume setting.

5. The Tone Volume of the selected zone will be displayed on screen. To the left of the ID scale, the selected zone will be displayed numerically.

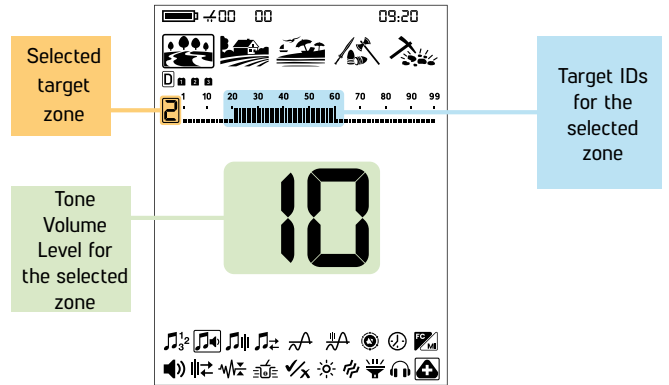

6. Using the Right and Left buttons, select the zone of which you want to change the Tone Volume.
7. Once the zone is selected, you can change the Tone Volume using the Up and Down buttons.
8. When the process is complete, press the Quick Settings button once to return to the extra settings. To go back to the main screen, press the Power / Settings button once.

Default Tone Volumes

Search Mode	1-Tone		2-Tone		3-Tone			4-Tone				6-Tone						99-Tone		P-Tone Pitch	
	Z-1	Z-1	Z-2	Z-1	Z-2	Z-3	Z-1	Z-2	Z-3	Z-4	Z-1	Z-2	Z-3	Z-4	Z-5	Z-6	Z-1	Z-2	Z-1	Z-2	
PARK	10	4	10	4	10	10	4	10	10	10	4	10	10	10	10	10	4	10	4	10	
FIELD	10	4	10	4	10	10	4	10	10	10	4	10	10	10	10	10	4	10	4	10	
BEACH	10	4	10	4	10	10	4	10	10	10	4	10	10	10	10	10	4	10	4	10	
RELIC	10	-	-	-	-	-	-	-	-	-	-	-	-	-	-	-	-	-	-	-	
GOLD	10	-	-	-	-	-	-	-	-	-	-	-	-	-	-	-	-	-	-	-	

3. Tone Frequency



This setting allows you to adjust the Tone Frequency for each tone zone.

This setting enables the users to easily identify targets by audio.

The Tone Frequency can be adjusted for each target zone. For example; in 6-Tone, you can adjust the Tone Frequency of each of the 6 zones separately.

Tone Frequency setting range is from 1 to 30.

Park Field Beach Tone Frequency setting is specific to the selected mode and the selected Target Tone Number, and any changes made affect only the Target Tone Number selected in that mode.

Tone Frequency setting does not work in the Gold and Relic modes.

Adjusting the Tone Frequency

1. Press the Power / Settings button once. Select the extra settings using the Right and Left buttons.
2. The extra settings top menu will appear on the screen. Press the Up button once.
3. Using the Right and Left buttons, select the Tone Frequency setting. The selected setting will be shown framed.

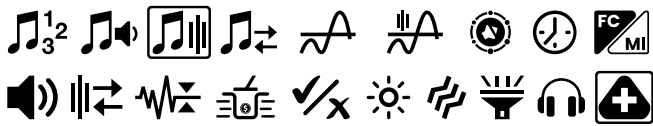

4. Press the Up button once to go into the Tone Frequency setting.
5. The Tone Frequency of the selected zone will be displayed on screen. To the left of the ID scale, the selected zone will be displayed numerically.

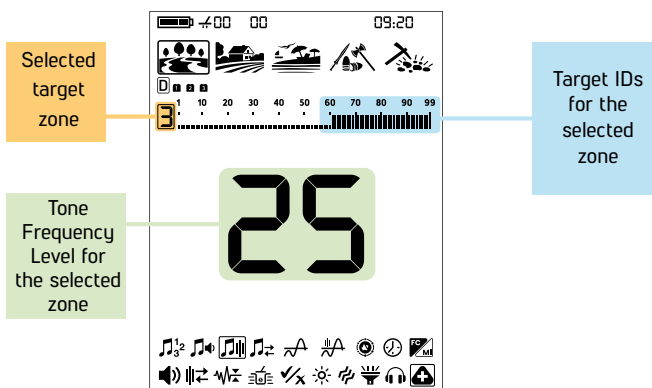

6. Using the Right and Left buttons, select the zone of which you want to change the Tone Frequency.

7. Once the zone is selected, you can change the Tone Frequency using the Up and Down buttons.

8. When the process is complete, press the Quick Settings button once to return to the extra settings. To go back to the main screen, press the Power / Settings button once.

Differences between 2-Tone and 99-Tone

The Target ID scale is divided into 2 zones as ferrous and non-ferrous both in 2-Tone and 99-Tone.

The Tone Frequency can be adjusted for both Zone-1 (Z-1) and Zone-2 (Z-2) to any number between 1 and 30. The user may even set both zones to the same number. However, this setting is used differently in the 99-tone.

In the 99-Tone, the Tone Frequency value set for Zone-1 (Z-1) must be lower than the Tone Frequency value set for Zone-2 (Z-2). For example: if the Tone Frequency value set for Zone-2 is 20, the Tone Frequency level for Zone-1 should be between 1 and 19. This applies to P-Tone Pitch as well.

IMPORTANT! To be able to distinguish between ferrous and non-ferrous targets, the Tone Frequency levels selected should be further away from each other.

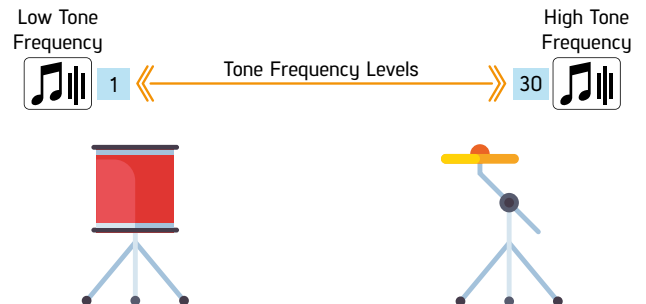

Default Tone Frequencies

Search Mode	1-Tone		2-Tone		3-Tone			4-Tone				6-Tone						99-Tone		P-Tone Pitch	
	Z-1	Z-1	Z-2	Z-1	Z-2	Z-3	Z-1	Z-2	Z-3	Z-4	Z-1	Z-2	Z-3	Z-4	Z-5	Z-6	Z-1	Z-2	Z-1	Z-2	
PARK	12	1	23	1	15	25	1	10	19	28	1	7	13	19	25	30	1	23	1	23	
FIELD	12	1	23	1	15	25	1	10	19	28	1	7	13	19	25	30	1	23	1	23	
BEACH	12	1	23	1	15	25	1	10	19	28	1	7	13	19	25	30	1	23	1	23	
RELIC	-	-	-	-	-	-	-	-	-	-	-	-	-	-	-	-	-	-	-	-	
GOLD	-	-	-	-	-	-	-	-	-	-	-	-	-	-	-	-	-	-	-	-	

4. Tone Break



The Tone Break setting allows you to move the point that separates the target zones.

The default Tone Break points may not provide you with the distinction you need between the targets you are looking for. With the Tone Break setting, you can adjust the start/end points of target zones.

Park Field Beach
P F B
 Relic R G Gold
 The Tone Break setting is specific to the selected mode and the selected Target Tone Number, and any changes made affect only the Target Tone Number selected in that mode.

When the Number of Tones is 1, Tone Break adjustment cannot be made. Therefore, Tone Break setting does not work in the Gold and Relic modes.

Adjusting the Tone Break

1. Press the Power / Settings button once. Select the extra setting using the Right and Left buttons.
2. The extra settings top menu will appear on the screen. Press the Up button once.
3. Using the Right and Left buttons, select the Tone Break setting. The selected setting will be shown framed.



4. Press the Up button to go into the Tone Break setting.

5. The Tone Break point of the selected zone will be displayed on screen. To the left of the ID scale, the selected zone will be displayed numerically.

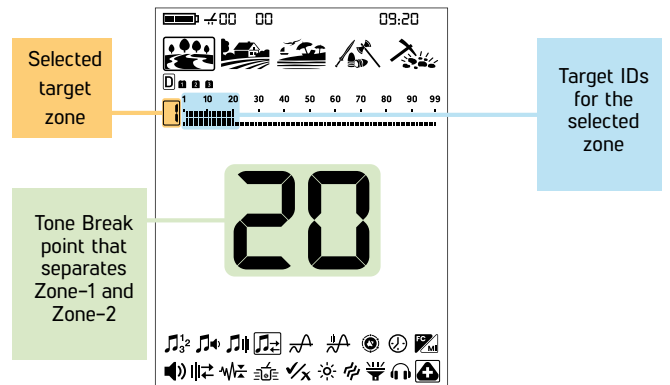

6. Using the Right and Left buttons, select the zone of which you want to change the Tone Break.

7. Once the zone is selected, you can change the Tone Break point using the Up and Down buttons.

8. When the process is complete, press the Quick Settings button once to return to the extra settings. To go back to the main screen, press the Power / Settings button once.

Default Tone Breaks

Search Mode	1-Tone		2-Tone		3-Tone			4-Tone				6-Tone					99-Tone	P-Tone Pitch
	Z-1	Z-1	Z-1	Z-2	Z-1	Z-2	Z-3	Z-1	Z-2	Z-3	Z-4	Z-5	Z-6	Z-1	Z-1			
PARK	-	20	20	55	20	35	75	20	35	55	75	89	20	20				
FIELD	-	21	21	55	21	35	75	21	35	55	75	89	21	21				
BEACH	-	20	20	55	20	35	75	20	35	55	75	89	20	20				
RELIC	-	-	-	-	-	-	-	-	-	-	-	-	-	-				
GOLD	-	-	-	-	-	-	-	-	-	-	-	-	-	-				

Default Tone Breaks for Zones 3 and 4

Zone-3 Default ID range: 36-55

Tone Break Point that Separates Zone-3 and Zone-4

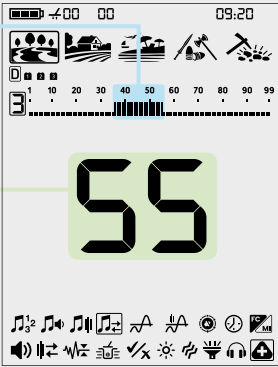

Zone-4 Default ID range: 56-75

Tone Break Point that Separates Zone-4 and Zone-5

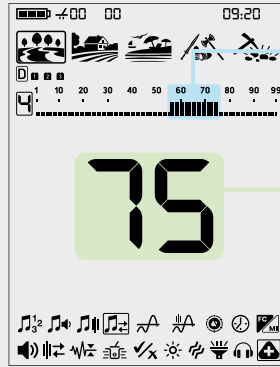

After moving the Tone Break point from 55 to 60

Zone-3 Target ID range: 36-60

Tone Break Point that Separates Zone-3 and Zone-4

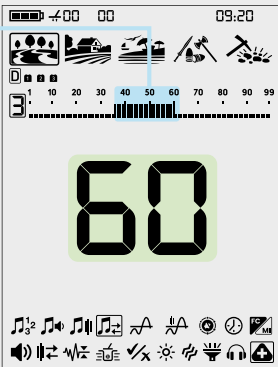

Zone-4 Target ID range: 61-75

Tone Break Point that Separates Zone-4 and Zone-5

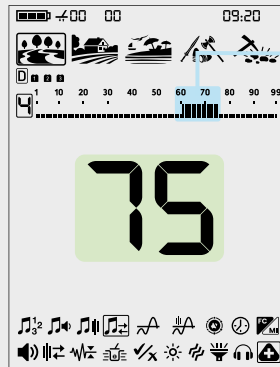

5. Threshold Level



This setting helps users identify targets more easily and makes the sounds of weak signals from small targets, such as gold nuggets, easier to hear.

When the Threshold Level setting is activated, The LEGEND 2 generates a sound which is continuously heard in the background and this sound is called the "Threshold".

Threshold Level range is from 0 to 30.

The frequency of the threshold tone can be adjusted by the Threshold Tone Frequency setting.

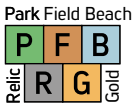

Threshold Level setting only affects the mode currently selected; changes made in one mode do not affect the others.

There is no Threshold Level setting in Relic mode.

Adjusting the Threshold Level

1. Press the Power / Settings button once. Select the extra settings using the Right and Left buttons.
2. The extra settings top menu will appear on the screen. Press the Up button once.
3. Using the Right and Left buttons, select the Threshold Level setting. The selected setting will be shown framed.

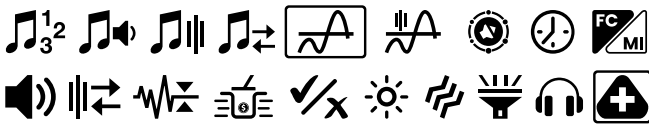

4. The current Threshold Level will be displayed on screen. Select the Threshold Level using the Up and Down buttons.

5. When the process is complete, you can return to the settings by pressing the Quick Settings button once. To return directly to the main screen, press the Power / Settings button once.

Threshold Tone for Rejected Targets

In Park, Field and Beach modes

The Threshold tone will blank to indicate detection of a rejected target.

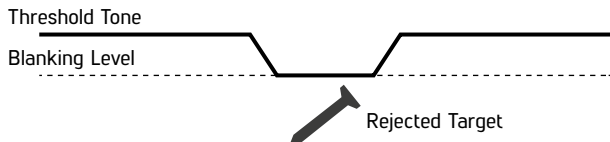

In Gold mode

When The LEGEND 2 detects a rejected target the threshold tone continues in the background.

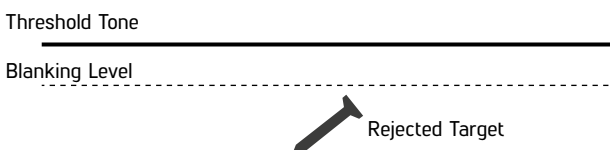

Default Threshold Levels

Search Mode	Threshold Level
PARK	0
FIELD	0
BEACH	0
RELIC	-
GOLD	14

The Threshold Level directly impacts the detection depth of smaller and deeper targets. If the threshold is set too low (0), weak signals of smaller or deeper targets may be missed. On the contrary, if the threshold is set too high (30), the device will be noisier, the threshold sound will be loud and the target responses will not be distinguished. Therefore, it is recommended to adjust it to a level where you can still hear the slight audio variations caused by a target.

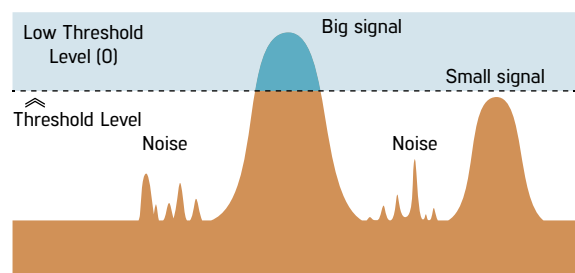
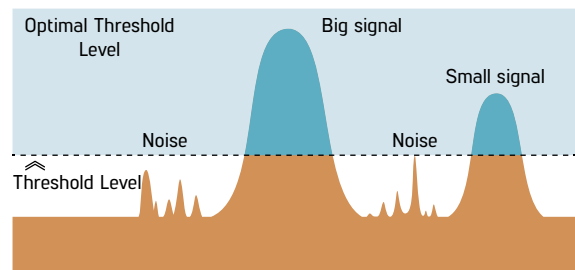
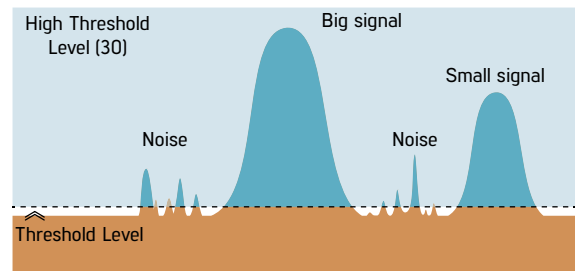

6. Threshold Frequency



This setting is used to adjust the tone frequency of the background hum. It offers a very wide frequency range. Threshold Frequency range is from 1 to 30.

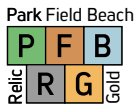

Threshold Frequency only affects the mode currently selected; changes made in one mode do not affect the others.

There is no Threshold Frequency setting in Relic mode.

Adjusting the Threshold Frequency

1. Press the Power / Settings button once. Select the extra setting using the Right and Left buttons.
2. The extra settings top menu will appear on the screen. Press the Up button once.
3. Using the Right and Left buttons, select the Threshold Frequency setting. The selected setting will be shown framed.

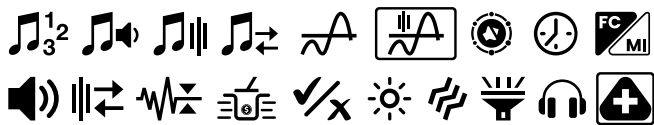

4. The current Threshold Frequency value will be displayed on screen. Select the Threshold Frequency using the Up and Down buttons.

5. When the process is complete, you can return to the settings by pressing the Quick Settings button once. To return directly to the main screen, press the Power / Settings button once.

Default Threshold Frequencies

Search Mode	Threshold Frequency
PARK	10
FIELD	10
BEACH	10
RELIC	-
GOLD	13

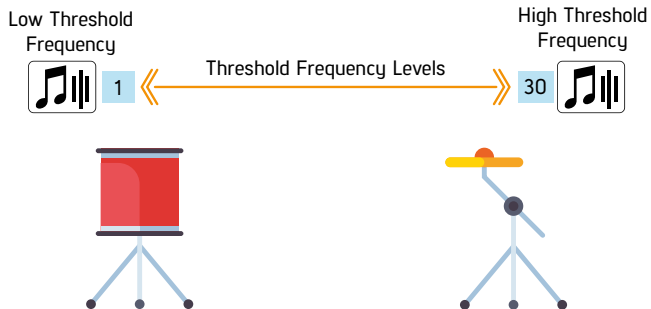

7. Audio Gain



The LEGEND 2 offers users the Audio Gain setting to convert target signals into audio using different response models. With the Audio Gain setting, users can select the signal-to-audio response model that best suits their preferences.

This feature is effective in increasing or decreasing the output volume of weak target signals.

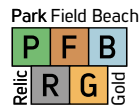

The Audio Gain setting only affects the mode currently selected; changes made in one mode do not affect the others.

The audio gain can be set to values between 1 and 6.

IMPORTANT! Audio Gain does NOT increase depth.

Adjusting the Audio Gain

1. Press the Power / Settings button once, then use the Right and Left buttons to select the extra settings.
2. The extra settings top menu will appear on the screen. Press the Up button once.
3. Use the Right and Left buttons to select the Audio Gain setting. The selected setting will be highlighted with a frame.

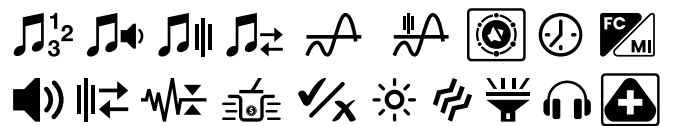

4. The current Audio Gain value will be displayed on the screen. Use the Up and Down buttons to select your desired value.

5. When the operation is complete, you can return to the settings by pressing the Quick Settings button once. To return directly to the main screen, press the Power / Settings button once.

Default Audio Gain Settings

Search Mode	Audio Gain
PARK	1
FIELD	1
BEACH	5
RELIC	3
GOLD	1

8. Clock and Usage Duration



The LEGEND 2 has a built in clock that is located in the right upper corner of the screen.

Setting the Clock

1. Press the Power / Settings button once, then use the Right and Left buttons to select the extra settings.
2. The extra settings top menu will appear on the screen. Press the Up button once.
3. Use the Right and Left buttons to select the Clock setting. The selected setting will be highlighted with a frame.

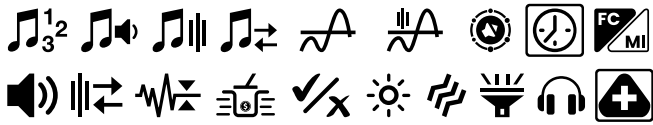

4. Press the Up button once on the selected setting. This will allow you to start setting the time on The LEGEND 2 device.
5. You will see numbers and a small line underneath them in the upper right corner. The line will be under the clock section. Using Up and Down buttons, first choose between 24-hour or 12-hour clock options (if 12-hour clock is selected, letter A for AM or letter P for PM will come up).

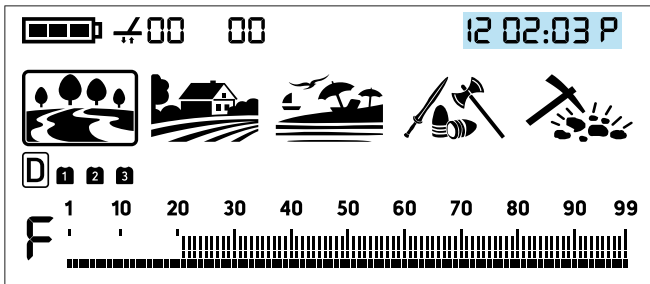

6. Then using the Right and Left buttons select the hour and minutes and set the time using the Up and Down buttons.
7. When the process is complete, press the Quick Settings button once to return to the extra settings. To return directly to the main screen, press the Power / Settings button once.

To provide LEGEND 2 users with a unique experience, the device records the total operating time from the moment it is first turned on and shares this information with the user.

Find Out the Usage Period

1. Press the Power / Settings button once, then use the Right and Left buttons to select the extra settings.
2. The extra settings top menu will appear on the screen. Press the Up button once.
3. Use the Right and Left buttons to select the Clock setting. The selected setting will be highlighted with a frame.
4. When the Time setting is selected, press and hold the Pinpoint & Accept/Reject button. While you continue holding it, the usage time will be displayed in the upper-right corner of the screen. In the usage time display, the fields shown as YY-MM-DD-HH indicate the device's total operating time in Years, Months, Days, and Hours, respectively.



5. When the process is complete, press the Quick Settings button once to return to the settings. To return directly to the main screen, press the Power / Settings button once.

9. FerroCheck™ / Mineralization Option



This setting allows the FerroCheck™ bars on the main screen to also serve as a mineralization indicator.

Park Field Beach



This setting is common to all modes; changes will take effect in all modes.

Changes made to this setting are stored in the device's memory, and when the device is powered off and on, it starts with the last selected setting.

Switching from the FerroCheck™ Indicator to the Mineralization Indicator

1. Press the Power / Settings button once, then use the Right and Left buttons to select the extra settings.
2. The extra settings top menu will appear on the screen. Press the Up button once.
3. Use the Right and Left buttons to select the FerroCheck™ / Mineralization setting. The selected setting will be highlighted with a frame.



4. The current value representing the indicator will be displayed on the screen. Use the Up and Down buttons to select your desired indicator. A value of 0 means the Mineralization indicator is displayed on the main screen, while a value of 1 means the FerroCheck™ indicator is displayed on the main screen.

5. When the process is complete, press the Quick Settings button once to return to the settings. To return directly to the main screen, press the Power / Settings button once.

WARNING MESSAGES

The device will shut down shortly after one of the below messages is displayed on screen:



Check Coil (CC)

It indicates an interruption in the search coil transmitter signal. The search coil connector may be unattached, loose or disconnected. If you own another detector with the same coil connector, please be sure that you have not attached the wrong coil by mistake. If none of the above exists, the search coil or its cable may have a defect. If the issue continues when you change the search coil, there may be an issue in the coil control circuit.



Low Battery (Lo)

When battery is depleted, "Lo" message appears on display and the device shuts down.



System Error (SE)

Turn the device back on if the device shuts down after this warning. If the problem persists, reset the device by pressing and holding the Power / Settings button for 30 seconds. If the problem still exists, contact technical service.

REVERTING BACK TO FACTORY DEFAULTS

To restore The LEGEND 2 device to factory settings, press and hold the Pinpoint & Accept/Reject button and the Power / Settings button while the device is powered off. The letters "Fd" (Factory Default) will appear on the screen. To proceed with the factory reset, continue holding the buttons until the letters "Ld" appear on the screen (approximately 3 seconds). When "Ld" is displayed, release both the Pinpoint & Accept/Reject button and the Power / Settings button. Your device will restart and return to factory default settings.

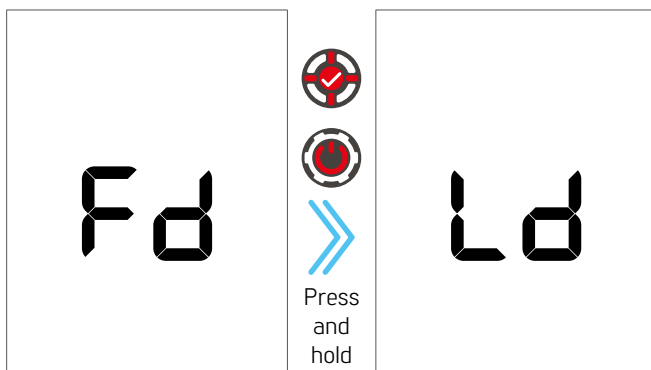

IMPORTANT! If the Pinpoint & Accept/Reject button is released while the letters "Fd" are displayed on the screen, the device will power on without returning to factory settings.

SOFTWARE UPDATE

The LEGEND 2 has software update capability. All software updates made after the device is released to the market will be announced on the product's web page along with updating instructions.

System Version Information:

The software version of The LEGEND 2 will be displayed at the upper right corner each time you turn the detector on.

HEADPHONES

The LEGEND 2 comes with Bluetooth® wireless headphones. The Bluetooth® headphones are NOT waterproof and should not be exposed to water.

The wireless connection will work as long as the system box of the device is not submerged in the water. In other words, you can use your wireless headphones while searching in shallow water with the coil submerged underwater. Please remember though, that the wireless headphones should not contact with water.

In case of the system box being submerged underwater, the wireless connection will not work. In this case, you need to purchase our optional Nokta Waterproof Headphones for land and underwater use. If you will not submerge the headphones underwater but just the system box, then you can also purchase our Nokta Headphones with waterproof connector.

For land use only, you can also purchase our optional headphones adapter should you want to use The LEGEND 2 with your own wired headphones.

TECHNICAL SPECIFICATIONS

55000609

Operating Frequencies_____:	Multi (3), 4 kHz, 10 kHz, 15 kHz, 20 kHz, 40 kHz
Audio Frequencies_____:	100 Hz – 1200 Hz adjustable
Search Modes_____:	5 (Park / Field / Beach / Relic / Gold)
Custom User Profiles_____:	15
Audio Tones_____:	99
Tone Volume_____:	Yes
Tone Break_____:	Yes
Tone Frequency_____:	Yes
Adjustable Threshold_____:	Yes
Notch Filter_____:	Yes
Ground Suppressor_____:	Yes
Ground Balance_____:	Automatic / Manual / Tracking
Pinpoint_____:	Yes
ID in Pinpoint_____:	Yes
Frequency Shift_____:	Yes
Noise Cancellation_____:	Yes
Vibration_____:	Yes
Sensitivity Setting_____:	30 levels
Target ID_____:	1-99
Search Coils_____:	Waterproof DD Search Coil & Cover – LD21 (8" × 5.5" / 21 cm x 14 cm) Waterproof DD Search Coil & Cover – LD28 (11" / 28 cm)
Display_____:	Custom LCD
Backlight_____:	Yes
Keypad Light_____:	Yes
LED Flashlight_____:	Yes
Weight_____:	1.2 kg (2.6lbs.) including the search coil
Length_____:	63 cm – 145 cm (25" – 57") adjustable
Battery_____:	6700 mAh Lithium Ion
Warranty_____:	3 years

The Bluetooth® word mark and logos are registered trademarks owned by Bluetooth® SIG, Inc.

Qualcomm® aptX™ is a product of Qualcomm Technologies, Inc.

Nokta Detectors reserves the right to change the design, specifications or accessories without notice and without any obligation or liability whatsoever.

RECOMMENDED ACCESSORIES

Waterproof DD Search Coil & Cover – LD38
(15" X 12" / 38 cm X 30 cm)



Waterproof DD Search Coil & Cover – LD22 (9" / 22 cm)



Bone Conduction Headphones



External Waterproof Battery



For Consumers within the European Union: Do not dispose of this equipment in general household waste. The crossed wheeled bin symbol on this equipment indicates this unit should not be disposed of in general household waste, but recycled in compliance with local government regulations and environmental requirements.



FCC STATEMENT

This device complies with Part 15 of the FCC Rules. Operation is subject to the following two conditions: (1) this device may not cause harmful interference, and (2) this device must accept any interference received, including interference that may cause undesired operation.



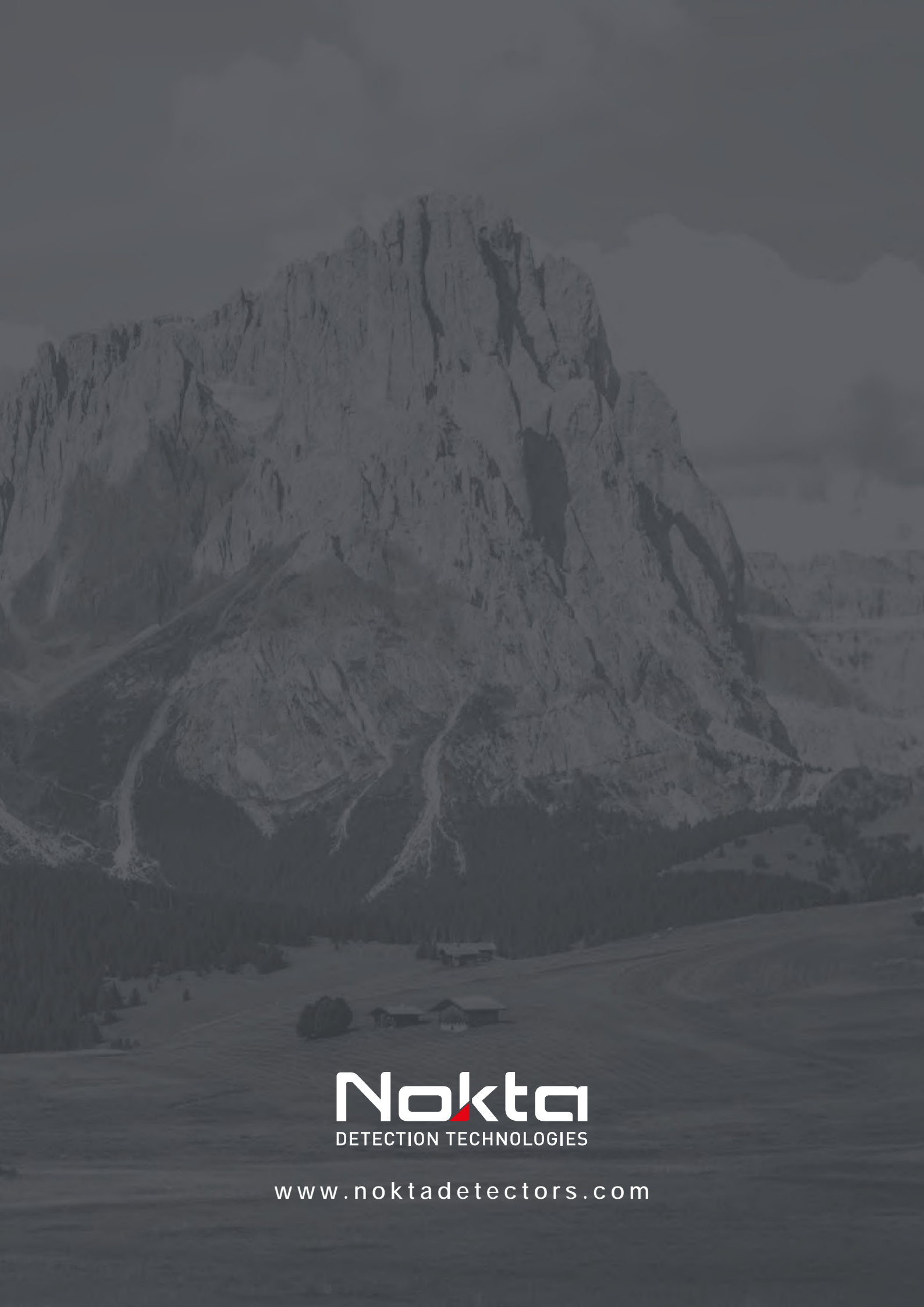

Nokta
DETECTION TECHNOLOGIES

www.noktadetectors.com